

- Threaded barrel, M8 x 1
- Stainless steel, 1.4427 SO
- Factor 1 for all metals
- Protection class IP68
- Resistant to magnetic fields
- Extended temperature range
- High switching frequency
- DC 3-wire, 10...30 VDC
- NO contact, NPN output
- M12 x 1 male connector

Wiring Diagram

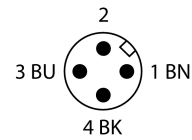
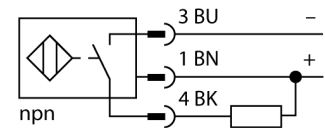

Type designation	NI4U-EG08-AN6X-H1341
Ident no.	4600650
Rated switching distance Sn	4 mm
Mounting conditions	Non-flush
Secured operating distance	≤ (0,81 x Sn) mm
Repeat accuracy	≤ 2 % of full scale
Temperature drift	≤ ± 10 %
Hysteresis	≤ ± 15 %, ≤ -25 °C v ≥ +70 °C
Ambient temperature	3...15 °C
	-30...+85 °C
Operating voltage	10...30 VDC
Residual ripple	≤ 10 % U _{ss}
DC rated operational current	≤ 150 mA
No-load current I ₀	≤ 15 mA
Residual current	≤ 0.1 mA
Isolation test voltage	≤ 0.5 kV
Short-circuit protection	yes/ Cyclic
Voltage drop at I ₀	≤ 1.8 V
Wire breakage/Reverse polarity protection	yes/ Complete
Output function	3-wire, NO contact, NPN
Protection class	☐
Switching frequency	2 kHz
Design	Threaded barrel, M8 x 1
Dimensions	57 mm
Housing material	Stainless steel, 1.4427 SO
Active area material	Plastic, PA12-GF30
Max. tightening torque housing nut	5 Nm
Electrical connection	Connectors, M12 x 1
Vibration resistance	55 Hz (1 mm)
Shock resistance	30 g (11 ms)
Protection class	IP68
MTTF	874 years acc. to SN 29500 (Ed. 99) 40 °C
Packaging unit	1
Switching state	LED, Yellow

Functional principle

Inductive sensors detect metal objects contactless and wear-free. *uprox®* Factor 1 sensors have significant advantages due to their patented ferrite-coreless multicoil system. They detect all metals at the same large switching distance and are resistant to magnetic fields.

**Inductive sensor
NI4U-EG08-AN6X-H1341**

Distance D	4 x B
Distance W	3 x Sn
Distance T	32 mm
Distance S	1.5 x B
Distance G	6 x Sn
Distance N	2 x Sn

Diameter active area B	Ø 8 mm
------------------------	--------

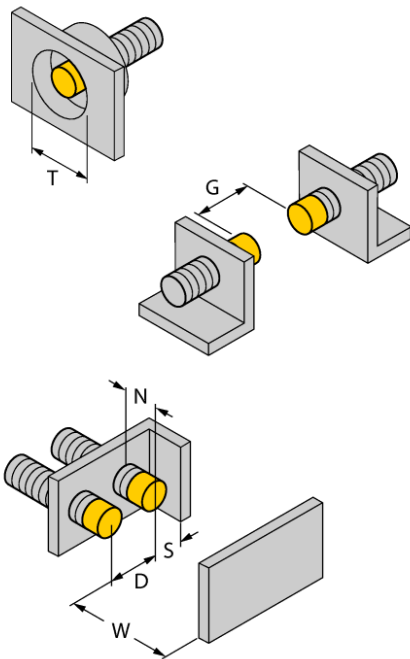

Accessories

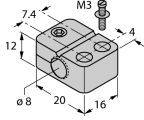
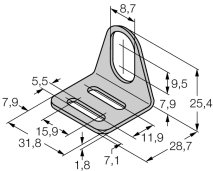
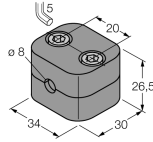
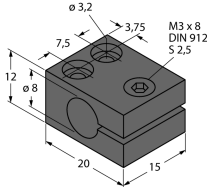
Type code	Ident no.	Description	
BST-08B	6947210	Fixing clamp for threaded barrel devices, with dead-stop; material: PA6	
MW-08	6945008	Mounting bracket for threaded barrel devices; material: Stainless steel A2 1.4301 (AISI 304)	
BSS-08	6901322	Mounting bracket for smooth and threaded barrel devices; material: Polypropylene	
MBS80	69479	Mounting bracket for threaded barrel devices; material mounting block: Anodized aluminium	

Wiring accessories

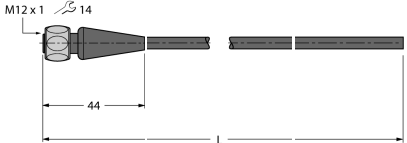
Type code	Ident no.	Description	
RKH4-2/TFE	6935482	Connection cable, M12 connector, female, straight, 3-pin, cable length: 2 m, sheath material: PVC, grey; temperature range: -25...+80 °C (in resting state), 0...+80 °C (in motion); other cable lengths and types available, see www.turck.com	

Wiring accessories

Type code	Ident no.	Description	
RKH4-2/TFG	6934384	Connection cable, M12 connector, female, straight, 3-pin, cable length: 2 m, sheath material: TPE, grey; temperature range: -40...+105 °C (in resting state), -25...+105 °C (in motion); other cable lengths and types available, see www.turck.com	