

Actuator and Sensor Cable, PUR Connection Cable RKC4.4T-5/TXL

TURCK

Industrial
Automation

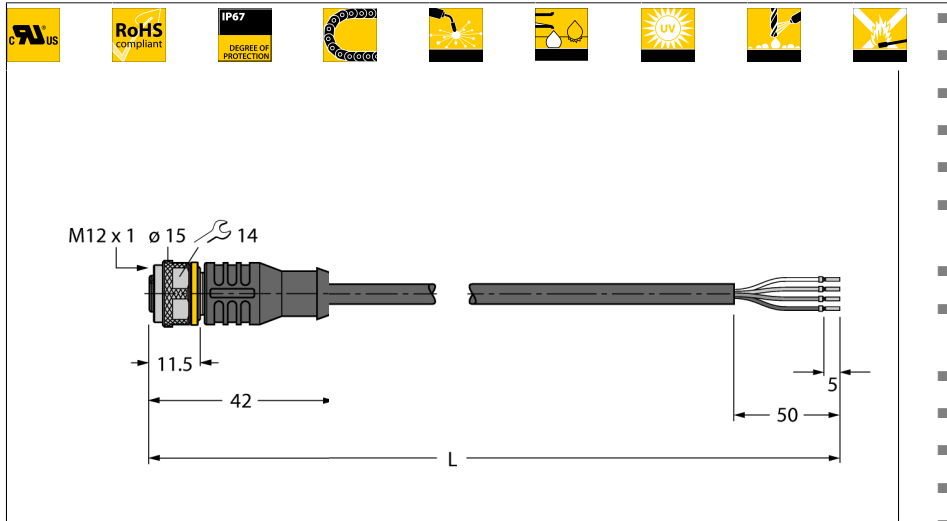

- Female M12, straight, 4-pin
- Sheath material: PUR
- Sheath color: black
- Qualified for drag chain use
- Resistant to weld splatter
- Resistant to chemicals, UV radiation and oils
- Flame retardant
- Free from halogen, silicone, PVC and LABS
- Particularly resistant to abrasion
- Approval: cULus
- RoHS conform
- Protection class IP67
- Cable length: 5.0 m

Type designation RKC4.4T-5/TXL
Ident no. 6625504

Connector A side	Female connector, M12x1, Straight
Number of pins	4
Contacts	Brass, CuZn, Gold-plated
Contact carriers	Plastic, TPU, Black
Grip	Plastic, TPU, Black
Coupling nut/screw	Brass, CuZn, Nickel-plated
Seal	Plastic, FPM/FKM
Protection class	IP67, A + B side screwed together
Mechanical lifespan	> 100 Mating cycles
Pollution degree	3
Tightening torque	0.8 ... 1 Nm (observe max. torque of counter piece!)

General data	
Cable diameter	4.7 ± 0.20mm
Cable length	5 m
Cable quality	PUR
Cable color	Black
Core insulation	PP
Core colors	BN, WH, BU, BK
Core cross-section	4x0.34 mm ²
Arrangement of strands	42x0.1 mm

Electrical features at +20 °C	
Current	4 A
Rated voltage	250 V
Insulation resistance	> 30.5 MΩ/km
Test voltage	2000 V
Forward resistance	max. 57 Ω/km

Mechanical and chemical properties	
Bending cycles	> 5 mil.
Bending radius (stationary laying)	> 5 x Ø
Bending radius (flexible use)	> 10 x Ø
Admissible acceleration	max. 5 m/s ²
Admissible travel path, horizontal	5 m (at 5 m/s ²)
Admissible travel path, vertical	2 m (at 5 m/s ²)
Admissible traversing speed	3.3 m/s
Torsional stress	± 180 °/m
Ambient temperature	
Stationary	-50...+80°C
In motion	-25...+80°C
Drag chain operation	-25...+60°C

Cable Cross-section

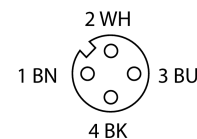
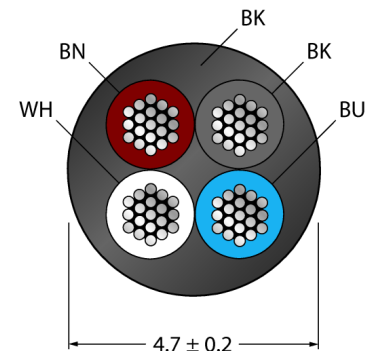

General information

Drawing shows design status including hexagon coupling nut
(Production start CW11/2016).

Circuit Diagram

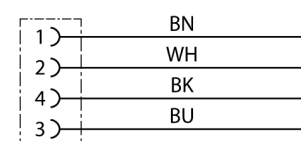



**Actuator and Sensor Cable, PUR
Connection Cable
RKC4.4T-5/TXL**

TURCK

Industrial
Automation

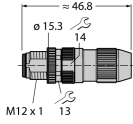
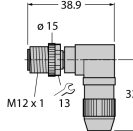
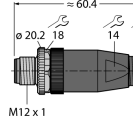
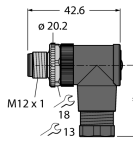
Accessories

Type code	Ident no.	Description	
HAS8141-0	6905406	Field-wireable male connector, M12 × 1, straight, 4-pin, insulation piercing connection, cable feedthrough 4.0 to 5.1 mm, core cross-section/terminal capacity 0.14 to 0.34 mm ² , plastic housing, metal nut	 <p>Technical drawing of the HAS8141-0 connector. It shows a side view with dimensions: total length ≈ 46.8 mm, diameter of the main body ø 15.3 mm, and a diameter of 14 mm for the terminal section. The thread is labeled M12 x 1 and the terminal length is 13 mm.</p>
HAS8241-0	6905400	Field-wireable male connector, M12 × 1, angled, 4-pin, insulation piercing connection, cable feedthrough 4.0 to 5.1 mm, core cross-section/terminal capacity 0.14 to 0.34 mm ² , plastic housing, metal nut	 <p>Technical drawing of the HAS8241-0 angled connector. It shows a side view with dimensions: total length 38.9 mm, diameter of the main body ø 15 mm, and a diameter of 13 mm for the terminal section. The thread is labeled M12 x 1.</p>
BS8141-0	69010	Field-wireable male connector, M12 × 1, straight, 4-pin, screw terminal connection, cable feedthrough 4.0 to 6.0 mm, core cross-section/terminal capacity 0.14 to 0.75 mm ² , plastic housing, metal nut	 <p>Technical drawing of the BS8141-0 screw terminal connector. It shows a side view with dimensions: total length ≈ 60.4 mm, diameter of the main body ø 20.2 mm, and a diameter of 18 mm for the terminal section. The thread is labeled M12 x 1.</p>
BS8241-0	69011	Field-wireable male connector, M12 × 1, angled, 4-pin, screw terminal connection, cable feedthrough 4.0 to 6.0 mm, core cross-section/terminal capacity 0.14 to 0.75 mm ² , plastic housing, metal nut	 <p>Technical drawing of the BS8241-0 angled screw terminal connector. It shows a side view with dimensions: total length 42.6 mm, diameter of the main body ø 20.2 mm, and a diameter of 18 mm for the terminal section. The thread is labeled M12 x 1.</p>
TORQUE-WRENCH-SET-AS	6936170	Torque wrench set; handles with adjustable torque 0.4-1.0 Nm, torque wrench for M8 (SW9), fork wrench for M12 (SW 14)	 <p>Image showing a torque wrench set. It includes a torque wrench with a black handle and a yellow grip, and a fork wrench with a black handle and a yellow grip. The torque wrench is labeled for M8 (SW9) and the fork wrench for M12 (SW 14).</p>

**Actuator and Sensor Cable, PUR
Connection Cable
RKC4.4T-5/TXL**

TURCK

Industrial
Automation

Accessories

Type code	Ident no.	Description	
BLANK-LABEL-FOR-CORDESETS-TEL-TXL	6936206	Label for TEL and TXL cables, length: 18 mm, height: 4 mm, material: polycarbonate (PC), color: white, halogen-free and flame-retardant	