

Color Area Vision Sensor



CVSE1-RA Series

CVSE1- □ 10-RA CVSE1- □ 20-RA CVSE1- □ 21-RA CVSE1- □ 40-RA

Instruction manual

- Thank you for purchasing this product. Before using this product, confirm that the product you have received is the product that you requested.
- Read this instruction manual thoroughly before use, and keep it in a safe location.



Indicates a possible hazard that may result in death, serious injury, WARNINGS or serious property damage if the product is used without observing the stated instructions.



Warning

- This product is not explosion-proof and should not be used around flammable or explosive gases or liquids.
- Doing so may cause injury, fire, or electric shock.
- This product cannot be used as protective equipment for the purpose of protecting the human body.



Caution

- It is dangerous to wire or attach/remove the connector while the power is on. Make sure to turn off the power before operation.
- Installing in the following locations may result in malfunction:
 1. Dusty or steamy locations.
 2. Locations where corrosive gas is generated.
 3. Locations with direct exposure to water or oil splashes.
 4. Locations where heavy vibrations or impacts may occur.
- The product is not designed for outdoor use.
- Do not wire with high voltage cables or power lines. Doing so may cause malfunction or damage by induction.
- Detection characteristics may vary depending on the state of the target object and variations among individual products.
- Do not use the product in water.
- Do not disassemble, repair, or modify this product. Doing so may cause injury, fire, or electric shock.
- Operate within the rated ranges.



For China RoHS, please refer to http://www.optex-fa.com/rohs_cn/.

Included accessories

Please confirm following accessories are included in the box.

- CVSE1- □□□ -RA
- This instruction manual
- Mounting screws (M4 x 50), 2 pcs. (including washers and nuts)

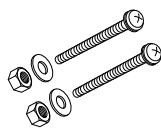
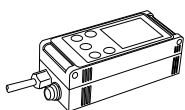

Specifications

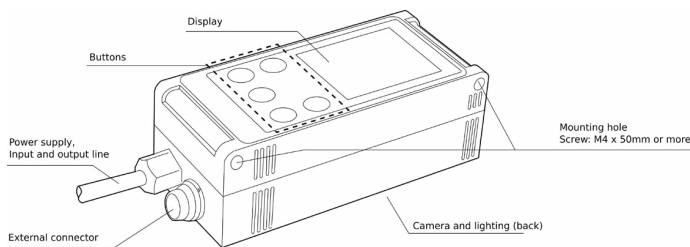

Model	CVSE1-N10-RA CVSE1-P10-RA	CVSE1-N20-RA CVSE1-P20-RA	CVSE1-N21-RA CVSE1-P21-RA	CVSE1-N40-RA CVSE1-P40-RA
Detection angle	10°	20°		40°
Working distance	210 to 270 mm	90 to 150 mm	31 to 39 mm	50 to 100 mm
Field of view(± 10%)	40 x 50 to 55 x 65 mm	40 x 50 to 65 x 75 mm	17 x 20 mm	46 x 55 to 82 x 98 mm
Light source	White LED, 12 pcs built-in			
Supply Voltage	12 to 24V DC ± 10%			
Power consumption	Max. 140mA / 24V DC			
Resolution	5 x 12 to 200 x 240			
LED light duration	Approx. 50000 hours (In normal temperature and humidity. Brightness level down by 1/2 of the initial level)			
Response time	2.9ms to 27.7ms. Factory setting:16.7ms			
Output signal	NPN or PNP open collector output x 1. Max. 100mA, residual voltage 1.0V or less			
Input	Bank selection x 4, Synchronous input x 1			
Operating temperature / Operating humidity	0°C to 40°C / 35% ~ 85%RH			
Storage temperature / humidity	-20 ~ +70°C / 35% ~ 95%RH			
Vibration	10 ~ 55Hz, Amplitude 1.5mm			
Shock resistance	50G (500m/s ²)			
Material	Housing : ABS ; Emitter and receiver: Acryl		Emitter and receiver: PC	
Protection structure	IP67			
Applicable regulations	EMC (2014/30/EU); RoHS (2011/65/EU, MIIT Order No.32)			
Applicable standards	EN 61000-6-2, EN61000-6-4			
Weight	Approx. 200g			

Dimensions

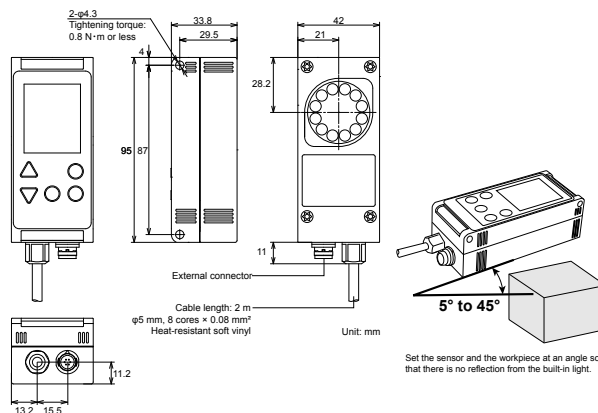

I/O circuit diagram

- Brown: 12 to 24V power
- Orange/Black: Bank select 0
- Yellow/Black: Bank select 1
- Pink: Bank select 2
- Red/Black: Bank select 3
- Purple: Synchronous input
- Black: Judgement output
- Blue: OV power

Bank select

Bank No.	3	2	1	0
No.0	OFF	OFF	OFF	OFF
No.1	OFF	OFF	OFF	ON
No.2	OFF	OFF	ON	OFF
No.3	OFF	OFF	ON	ON
No.4	OFF	ON	OFF	OFF
No.5	OFF	ON	OFF	ON
No.6	OFF	ON	ON	OFF
No.7	OFF	ON	ON	ON
No.8	ON	OFF	OFF	OFF
No.9	ON	OFF	OFF	ON
No.10	ON	OFF	ON	OFF
No.11	ON	OFF	ON	ON
No.12	ON	ON	OFF	OFF
No.13	ON	ON	OFF	ON
No.14	ON	ON	ON	OFF
No.15	ON	ON	ON	ON

NPN wiring

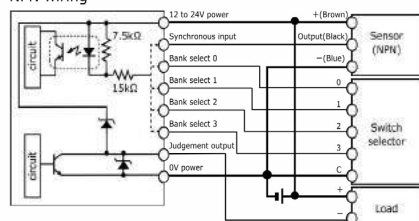

PNP wiring

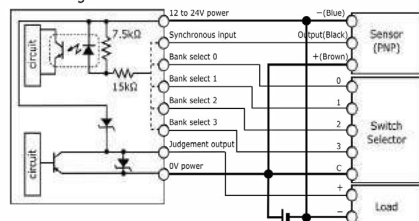

Options

Category	Model	Description
Remote monitor	CVS-M1-R	Monitor unit for use with the CVS series. This allows results to be checked away from workpiece and can be set up similar to the main unit.
D-sub cable	CVS-C2C	D-sub cable connects the CVS series to PC.
Extension cable	CVS-C3S	This cable extends the dedicated cable or the remote monitor cable. Up to 4 extension cables can be used (up to 15m).

Screen description

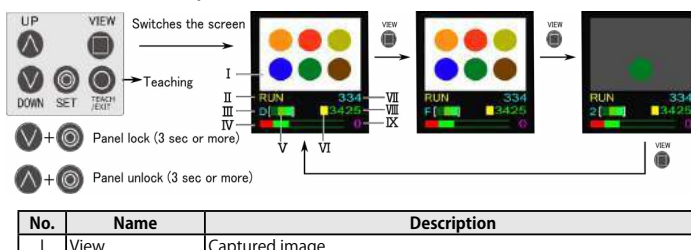

No.	Name	Description
I	View	Captured image.

II	Mode	RUN: Sensor running. Others: Teaching or setting parameter
III	Screen mode	Screen display mode. D: displays the captured image. F: displays the image after correction process. 2: displays the detected image.
IV	Area bar graph	Displays the Area in the bar graph. Red : Out of range, Green : Within range.
V	Target colors	To detect colors at image. Left is darkest color and middle is middle tone, right is brightest color.
VI	Output signal	Output status ■ : ON ■ : OFF
VII	Response time	Time from snapshot to output signal. per 0.1ms
VIII	Area	Area of detected colors. Red : Out of range, Green : Within range.
IX	Bank No.	Current bank number.

Setting language

It turned on while pressing **A** button, will be Japanese.

It turned on while pressing **V** button, will be English.

Teaching

Teaching Process:

- Initial Screen:** Shows color selection (TEACH? YES) and zoom (ZOOM? F). Navigation: **A** Yes or **V** No and next, **○** Next.
- Select FOV:** **A** Zoom In or **V** Zoom Out, **○** Next.
- Color Selection:**
 - Retry with brighter:** **▲**
 - Retry with darker:** **▼**
 - Retry with smoother accuracy:** **○**
 - Retry with rougher accuracy:** **○**
- Shutter time and Accuracy:** **○** Shutter time, **○** Accuracy.
- Select target color:** **A** Cursor move right, **V** Cursor move left, **○** Next.
- Select Color rage:** **A** Expansion, **V** Contraction, **○** Next.
- Saves teaching parameters:** **A** Yes, **V** No and **○** finish teaching.

Setting parameter

● Setting items (purple symbols could be set for each bank)

Parameter Setting Flow:

- Running:** Shows current parameters (AREA LO 3000, D 3425, 334).
- Setting parameter:** **A** previous parameter, **V** next parameter, **○** save and back, **○** revert and back.
- Edit parameter:** **A** previous value, **V** next value, **○** save and back, **○** revert and back.

Point: If you go to Extended setting parameter, Press **○** with 3 sec. or more

Name	Symbol	Range (Default)	Description
Area lower limit	AREA LO	0 to 9999 (5000)	Lower limit value for the detection area. If detected area value is lower than this value, output signal is off.
Color margin	COLOR%	0 to 127 (20)	Adjustments range of target color. * Set a lower value to detect subtle color differences. (5 to 20) * Set a higher value to increase stability. (20 or higher)
Shutter time	BRIGHT	0 to 255 (100)	Shutter time (value x 54.5us). It is automatically adjusted in teaching.
Zoom	ZOOM	0 to 19 (0)	Zoom in center area.
Area higher limit	AREA HI	0 to 9999 (9999)	Higher limit value for the detection area. If detected area value is higher than this value, output signal is off.

● Extended setting items (purple symbols could be set for each bank)

Name	Symbol	Range (Default)	Description
Color filter	COLORFIL	FIX / FLOW (FIX)	FIX: Corrects the brightness with RGB ratio per pixel. It is resistant to shadows and uneven illumination, but not suitable for achromatic (black and white) use. FLOW: Corrects the brightness with right end pixel. It is suitable for detection of low contrast image.
Bank copy	BKCOPY	0 to 15 (0)	Copies the current bank parameters to the specified bank.
Baud rate	BAUD	9600 /14K4 /57K6 /115K (115K)	RS232-C(in External connector) baud rate. 9600 : 9.6kbps 14K4 : 14.4kbps 57K6 : 57.6kbps 115K : 115.2kbps
LED luminance difference	LED PAN	0 to 100 (50)	Adjusts the percentage of brightness of the top and bottom of built-in lights. 0: lights on only the top of built-in light. 50: light on both the top and bottom of built-in light. 100: light on only the bottom of built-in light.
LED brightness	LED BRI	0 to 255 (170)	Adjusts brightness of built-in light. 0: lights off. 255: lights on.
Language	LANGUAGE	ニホン /ENG (ニホン)	Select language. ニホン : Japanese, ENG: English
Synchronous input	SYNCHRO	LOW / DOWN / HIGH / UP / CONT (CONT)	Specify trigger input mode and timing. LOW: Low level trigger DOWN : Falling edge trigger HIGH: High level trigger UP: Rising edge trigger CONT: Always snapshot
Synchronous input delay	SYNCDLY	0 to 255 (0)	Adds delay to Synchronous input signal. The time unit, refer to DLYUNIT.
Delay unit	DLYUNIT	0 to 2 (0)	Delay unit of the synchronous input signal. 0: 64 μ s 1: 1ms 2: 10ms.
Resolution	RESOLUT	NORM / H-SP (NORM)	NORM: High resolution mode. It used for detection of subtle color differences and fine print. H-SP: High speed mode. It used for getting quick response.
Judgement output spec.	OUTSIDE	IN / OUT (IN)	Conditions to turn on the judgement output. IN: When the detection area is in the range of AREA LO and AREA HI. OUT: When the detection area is out the range of AREA LO and AREA HI.
One shot output	ONESHOT	OFF / ON (OFF)	OFF: Judgement output is level output. ON: Judgement output is delayed by ON DLY.
On delay time	ON DLY	0 to 5000 (0)	Turns on the judgement output to this value after the elapse of processing. Unit is ms.
Off delay time	OFF DLY	0 to 5000 (0)	If ONESHOT is OFF, it turns off the judgement output to this value after the elapse of processing. If ONESHOT is ON, it turns on the judgement output only this value. Unit is ms.
Light ON/OFF	LIGHT	OFF / ON (ON)	Turns on/off the built-in lights.
LCD vertical flip	LCDDVIEW	NORM / REVS (NORM)	NORM: Normal orientation. REVS: Upside-down display.
Darkness correction	KIL BLK	0 to 31 (27)	Corrects brightness variation. 0: weak to 31: strong. e.g. 0 to 10: lighting check, 10 to 20: color less, 24 to 28: standard, 29 to 31: low contrast.
Initialization	INITIAL	BANK / ALL	BANK: Initializes current bank parameters. ALL: Initializes all parameters.
Input time constant	IN FILT	160U /2.5M /5MS /7.5M /10MS (10MS)	The input time constant (noise removal time) for bank switching. 160U: 160 μ s 2.5M: 2.5ms 5MS: 5ms 7.5M: 7.5ms 10MS: 10ms
Bank selection	BANK	0 ~ 15 /BKIN (BKIN)	0 to 15: Set the specified bank. BKIN: Specified by bank switching inputs.

● Relationship between response time and parameters (per ms)

ZOOM	RESOLUT=H-SP	RESOLUT=NORM	ZOOM	RESOLUT=H-SP	RESOLUT=NORM
0	16.7	27.7	10	9.4	16.9
1	15.9	26.7	11	8.7	15.8
2	15.1	26.1	12	7.9	14.7
3	14.5	24.6	13	7.2	13.6
4	13.8	23.4	14	6.5	12.5
5	13.0	22.3	15	5.8	11.4
6	12.3	21.2	16	5.0	10.4
7	11.6	20.2	17	4.3	9.2
8	10.9	19.0	18	3.6	8.1
9	10.2	17.9	19	2.9	7.1

* In the case of SYNCRO=HIGH and BRIGHT=100

- All specifications may be changed without notice.

- For more information, questions and comments regarding products, please contact us below.

Manufactured and sold by :

OPTEX FA CO.,LTD.

91 Chudoji-Awata-cho Shimogyo-ku Kyoto 600-8815 JAPAN
TEL : +81-(0)75-325-2920
FAX: +81-(0)75-325-2921
Website : <http://www.optex-fa.com>