

**Inductive sensor
With analog output
BI8-M18-LIU**

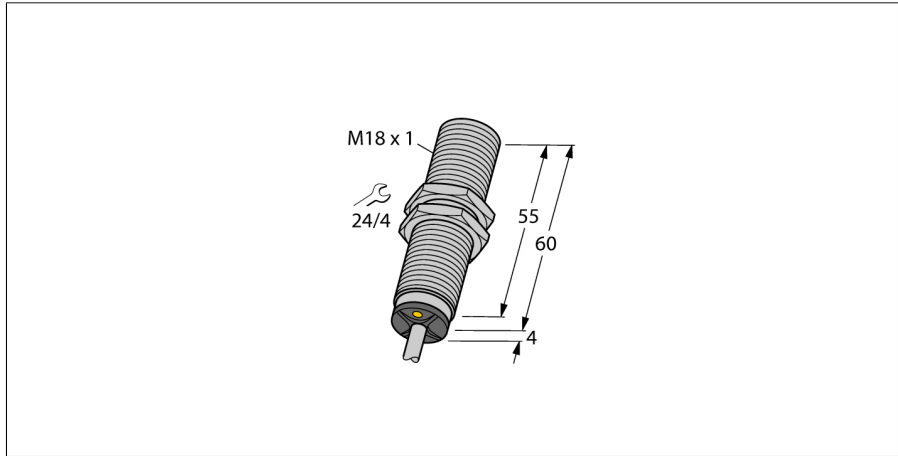

- Threaded barrel, M18 x 1
- Chrome-plated brass
- 4-wire, 15...30 VDC
- Analog output
- 0...10 V and 0...20 mA
- Cable connection

Wiring Diagram

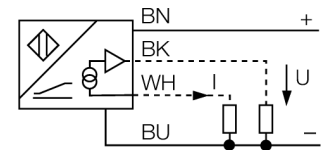

Measuring Range

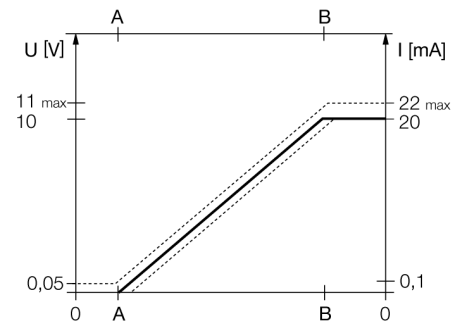

Type designation	BI8-M18-LIU
Ident-No.	1535538
Measuring range	1...5 mm mm
Mounting conditions	Flush
Correction factors	St37 = 1; Al = 0.3; stainless steel = 0.7; Ms = 0.4
Repeatability	≤ 1 % of measuring range A - B
	≤ 0.5 %, after warm-up 0.5 h
Reproducibility	≤ 40 μm
	≤ 20 μm, after a warm-up time of 0.5 h
Linearity deviation	≤ 5 %
Temperature drift	≤ ± 0.06 % / K
Ambient temperature	-25...+70 °C
Operating voltage	15...30 VDC
Residual ripple	≤ 10 % U _{in}
No-load current I ₀	≤ 8 mA
Isolation test voltage	≤ 0.5 kV
Short-circuit protection	yes
Wire breakage/Reverse polarity protection	no/ Complete
Output function	4-wire, Analog output
Voltage output	0...10V
Current output	0...20 mA
Load resistance voltage output	≥ 4.7 kΩ
Load resistance, current output	≤ 0.4 kΩ
Measuring sequence frequency	200 Hz
Design	Threaded barrel, M18 × 1
Dimensions	64 mm
Housing material	Metal, CuZn, Chrome-plated
Active area material	Plastic, PA12-GF30
End cap	Plastic, EPTR
Max. tightening torque housing nut	25 Nm
Electrical connection	Cables
Cable quality	5.2mm, Gray, LifYY, PVC, 2
Cable cross section	4 x 0.34 mm ²
Vibration resistance	55 Hz (1 mm)
Shock resistance	30 g (11 ms)
Protection class	IP67
MTTF	751 years acc. to SN 29500 (Ed. 99) 40 °C
Packaging unit	1

Inductive sensor
With analog output
BI8-M18-LIU

Distance D	2 x B
Distance W	12 mm
Distance T	3 x B
Distance S	1.5 x B
Distance G	24 mm
<hr/>	
Diameter active area B	Ø 18 mm



**Inductive sensor
With analog output
BI8-M18-LIU**

Accessories

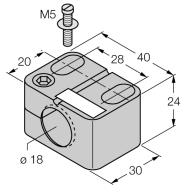
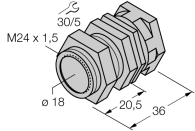
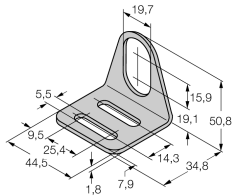
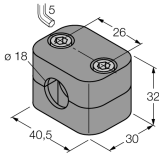
Type code	Ident-No.	Description	
BST-18B	6947214	Fixing clamp for threaded barrel devices, with dead-stop; material: PA6	
QM-18	6945102	Quick-mount bracket with dead-stop; material: Chrome-plated brass Male thread M24 x 1.5. Note: The switching distance of proximity switches can be reduced by the use of quick-mount brackets.	
MW-18	6945004	Mounting bracket for threaded barrel devices; material: Stainless steel A2 1.4301 (AISI 304)	
BSS-18	6901320	Mounting bracket for smooth and threaded barrel devices; material: Polypropylene	
IM43-13-SR	7540041	Trip amplifier; 1-channel; input 0/4...20 mA or 0/2...10 V; supply of 2- or 3-wire transmitters/sensors; limit value adjustment via teach button; three relay outputs with one NO contact each; removable terminal blocks; 27 mm wide; universal voltage supply 20...250 VUC; further Limit value indicators are described in our "Interface Technology" catalog.	