

▪ CLAMP MULTIMETER





F205



ENGLISH

User's manual

CONTENTS

1	PRESENTATION.....	8
1.1	THE SWITCH.....	9
1.2	THE KEYS OF THE KEYPAD.....	10
1.3	THE DISPLAY UNIT.....	11
1.3.1	<i>The symbols of the display unit.....</i>	11
1.3.2	<i>Measurement capacity exceeded (O.L).....</i>	13
1.4	THE TERMINALS.....	13
2	THE KEYS.....	13
2.1	KEY.....	13
2.2	KEY (SECOND FUNCTION).....	14
2.3	KEY.....	15
2.4	KEY.....	15
2.4.1	<i>In the normal mode.....</i>	15
2.4.2	<i>The MAX/MIN/PEAK mode + activation of the HOLD mode.....</i>	16
2.4.3	<i>Access to the True-INRUSH mode ( set to ).....</i>	17
2.5	KEY.....	17
2.5.1	<i>The Hz function in the normal model.....</i>	17
2.5.2	<i>The Hz function + activation of the HOLD mode.....</i>	18
2.6	KEY.....	18
3	USE.....	19
3.1	COMMISSIONING.....	19
3.2	STARTING UP THE CLAMP MULTIMETER.....	20
3.3	SWITCHING THE CLAMP MULTIMETER.....	20
3.4	CONFIGURATION.....	20
3.4.1	<i>Programming of the maximum resistance allowed for a continuity.....</i>	21
3.4.2	<i>De-activation of automatic switching off (Auto Power OFF).....</i>	21
3.4.3	<i>Programming of the current threshold for the True INRUSH measurement</i>	21
3.4.4	<i>Default configuration.....</i>	22
3.5	VOLTAGE MEASUREMENT (V).....	22
3.6	CONTINUITY TEST 	23
3.6.1	<i>Automatic compensation of the resistance of the leads.....</i>	24
3.7	RESISTANCE MEASUREMENT Ω	24
3.8	DIODE TEST 	25
3.9	CURRENT MEASUREMENT (A).....	25
3.9.1	<i>AC measurement.....</i>	25
3.9.2	<i>DC or AC+DC measurement.....</i>	26
3.10	STARTING CURRENT OR OVERCURRENT (TRUE INRUSH) MEASUREMENT	

3.11	POWER MEASUREMENTS W, VA, VAR AND PF	27
3.11.1	Measurement of single-phase power.....	28
3.11.2	Balanced three-phase power measurement.....	28
3.12	“DIRECTION OF ROTATION OF THE PHASES” OR “ORDER OF THE PHASES” MODE 	29
3.13	FREQUENCY MEASUREMENT (Hz)	30
3.13.1	Frequency measurement in voltage.....	30
3.13.2	Frequency measurement in current.....	31
3.13.3	Measurement of frequency in power.....	31
3.14	MEASUREMENT OF THE LEVEL OF HARMONICS (THD) AND OF THE FREQUENCY OF THE FUNDAMENTAL (NETWORK).....	31
3.14.1	Measurement of the THD and of the frequency of the fundamental in voltage 32	
3.14.2	Measurement of the THD and of the frequency of the fundamental in current 32	
4	CHARACTERISTICS.....	34
4.1	REFERENCE CONDITIONS	34
4.2	CHARACTERISTICS UNDER THE REFERENCE CONDITIONS.....	34
4.2.1	DC voltage measurement.....	34
4.2.2	AC voltage measurement	35
4.2.3	AC+DC voltage measurement	36
4.2.4	DC current measurement.....	36
4.2.5	AC current measurement	37
4.2.6	AC+DC intensity measurement.....	37
4.2.7	True-Inrush measurement.....	38
4.2.8	Continuity measurement	38
4.2.9	Resistance measurement	38
4.2.10	Diode test.....	39
4.2.11	Active DC power measurements	39
4.2.12	Active AC power measurements.....	40
4.2.13	Active AC+DC power measurements.....	41
4.2.14	Measurement of apparent AC power	42
4.2.15	Measurement of apparent AC+DC power	42
4.2.16	Measurement of reactive AC power.....	43
4.2.17	Measurement of reactive AC+DC power.....	43
4.2.18	Calculation of the power factor	44
4.2.19	Frequency measurements.....	45
4.2.20	Characteristics in THDr.....	45
4.2.21	Characteristics in THDf.....	45
4.2.22	Indication of order of the phases	46
4.3	ENVIRONMENTAL CONDITIONS	46
4.4	CHARACTERISTICS OF CONSTRUCTION	47
4.5	POWER SUPPLY	47
4.6	COMPLIANCE WITH INTERNATIONAL STANDARDS	47

- 4.7 VARIATIONS IN THE DOMAIN OF USE48
- 5 MAINTENANCE..... 49**
 - 5.1 CLEANING.....49
 - 5.2 REPLACEMENT OF THE BATTERY.....49
 - 5.3 METROLOGICAL CHECK.....49
 - 5.4 REPAIR49
- 6 WARRANTY 50**
- 7 DELIVERY CONDITION..... 50**

You have just acquired an **F205 clamp multimeter** and we thank you.

For best results from your device :

- **read** this user manual attentively,
- **observe** the precautions for its use.

Meanings of the symbols used on the device



Danger. The operator agrees to refer to this data sheet whenever this danger symbol is encountered.



Application or withdrawal authorized on uninsulated or bare conductors at dangerous voltages.



9 V battery.



The CE marking indicates compliance with European directives.



Double insulation or reinforced insulation.



Selective sorting of wastes for the recycling of electrical and electronic equipment within the European Union.



In conformity with directive DEEE 2002/96/EC: this equipment must not be treated as household waste.



AC – Alternating current.



AC and DC – Alternating and direct current.



Earth.



Risk of electric shock.

PRECAUTIONS FOR USE

This device complies with safety standards IEC-61010-1 and 61010-2-032 for voltages of 1000V in category III or 600V in category IV at an altitude OF less than 2000m, indoors, with a degree of pollution not exceeding 2.

These safety instructions are intended to ensure the safety of persons and proper operation of the device. If the tester is used other than as specified in this data sheet, the protection provided by the device may be impaired.

- The operator and/or the responsible authority must carefully read and clearly understand the various precautions to be taken in use.
- If you use this instrument other than as specified, the protection it provides may be compromised, thereby endangering you.
- Do not use the instrument in an explosive atmosphere or in the presence of flammable gases or fumes.
- Do not use the instrument on networks of which the voltage or category exceeds those mentioned.
- Do not exceed the rated maximum voltages and currents between terminals or with respect to earth.
- Do not use the instrument if it appears to be damaged, incomplete, or not properly closed.
- Before each use, check the condition of the insulation on the leads, housing, and accessories. Any element of which the insulation is deteriorated (even partially) must be set aside for repair or scrapped.
- Use leads and accessories rated for voltages and categories at least equal to those of the instrument. If not, an accessory of a lower category lowers the category of the combined Clamp + accessory to that of the accessory.
- Observe the environmental conditions of use.
- Do not modify the instrument and do not replace components with "equivalents". Repairs and adjustments must be done by approved qualified personnel.
- Replace the battery as soon as the  symbol appears on the display unit. Disconnect all cords before opening the battery compartment cover.
- Use personal protective equipment when conditions require.
- Keep your hands away from the unused terminals of the instrument.

- When handling the test probes, crocodile clips, and clamp ammeters, keep your fingers behind the physical guard.
- As a safety measure, and to avoid repeated overloads on the inputs of the device, we recommend performing configuration operations only when the device is disconnected from all dangerous voltages.

MEASUREMENT CATEGORIES

Definitions of the measurement categories :

CAT II: Circuits directly connected to the low-voltage installation.

Example: power supply to household electrical appliances and portable tools.

CAT III: Power supply circuits in the installation of the building.

Example: distribution panel, circuit-breakers, fixed industrial machines or devices.

CAT IV: Circuits supplying the low-voltage installation of the building.

Example: power lines, meters, and protection devices.

1 PRESENTATION

The **F205** is a professional electrical measuring instrument that combines the following functions:

- Current measurement;
- Measurement of inrush current / overcurrent (True-Inrush);
- Voltage measurement;
- Frequency measurement;
- Measurement of level of harmonics (THD)
- Continuity test with buzzer;
- Resistance measurement;
- Diode test;
- Power measurements (W, VA, var and PF);
- Indication of the order of the phases.

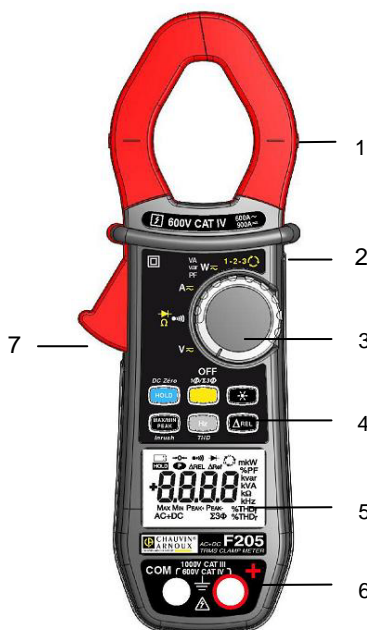

Item	Designation	See §
1	Jaws with centring marks (see connection principles)	3.5 to 3.14
2	Physical guard	-
3	Switch	1.1
4	Function keys	2
5	Display unit	1.3
6	Terminals	1.4
7	Trigger	-

Figure 1 : the F205 clamp multimeter

1.1 THE SWITCH

The switch has six positions. To access the V_{\approx} , Ω , A_{\approx} , W_{\approx} , $1-2-3$, functions, set the switch to the desired function. Each setting is confirmed by an audible signal. The functions are described in the table below.

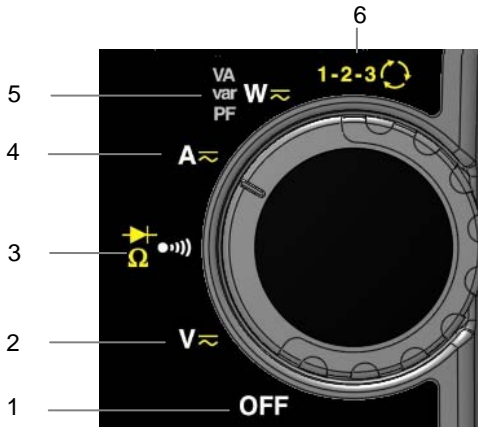

Figure 2 : the switch

Item	Function	See §
1	OFF mode – Switches the clamp multimeter off	3.3
2	AC, DC, AC+DC voltage measurement (V)	3.5
3	Continuity test $\bullet\text{---}\text{ }$) Resistance measurement Ω Diode test $\rightarrow $	3.6 3.7 3.8
4	AC, DC, AC+DC current measurement (A)	3.9
5	Power measurements (W, var, VA) and calculation of the power factor (PF) AC, DC, AC+DC	3.11
6	Indicator of the order of the phases $1-2-3$	3.12

1.2 THE KEYS OF THE KEYPAD

Here are the six keys of the keypad :

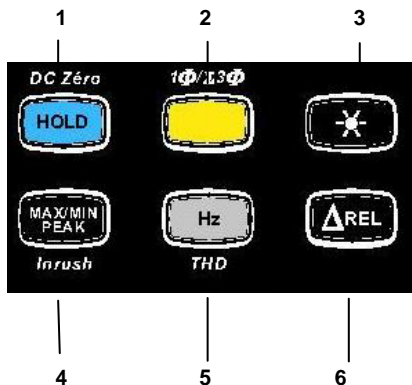

Figure 3 : the keys of the keypad

Item	Function	See §
1	Storage of values, disabling of display Zero correction $A_{DC}/A_{AC+DC}/W_{DC}/W_{AC+DC}$ Compensation of the resistance of the leads in the continuity and ohmmeter function	2.1 3.9.2 3.6.1
2	Selection of the type of measurement (AC, DC, AC+DC) Selection of single-phase or three-phase measurement	2.2
3	Activation or de-activation of the backlighting of the display unit	2.3
4	Activation or de-activation of the MAX/MIN/PEAK mode Activation or de-activation of the INRUSH mode in A	2.4
5	Measurements of frequency (Hz), of the level of harmonics (THD) Display of the powers W, VA, var and PF	2.5
6	Activation of the ΔREL mode – Display of relative and differential values	2.6

1.3 THE DISPLAY UNIT

Here is the display unit of the clamp multimeter:

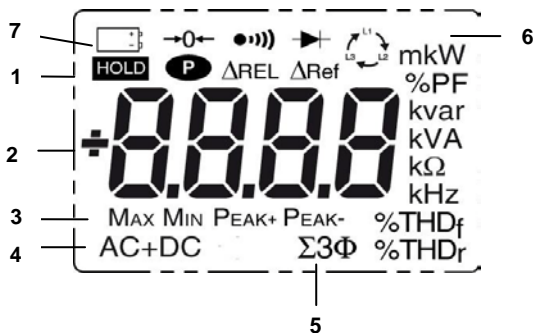







Figure 4 : the display unit

Item	Function	See §
1	Display of the modes selected (keys)	2
2	Display of the measurement value and unit	3.5 to 3.12
3	Display of the MAX/MIN/PEAK modes	2.4
4	Type of measurement (AC or DC)	2.2
5	Total three-phase power measurements	3.11.2
6	Display of the selected modes (switch)	3.5
7	Spent battery indication	5.2

1.3.1 The symbols of the display unit

Symbol	Designation
AC	Alternating current or voltage
DC	Direct current or voltage
AC+DC	Alternating and direct current or voltage
ΔREL	Relative value, with respect to a reference
ΔRef	Reference value

HOLD	Storage of the values and hold of the display
Max	Maximum RMS value
Min	Minimum RMS value
Peak+	Maximum peak value
Peak-	Minimum peak value
$\Sigma 3\Phi$	Balanced total three-phase power measurement
V	Volt
Hz	Hertz
W	Watt
A	Ampere
%	Percentage
Ω	Ohm
m	Milli- prefix
k	Kilo- prefix
var	Reactive power
VA	Apparent power
PF	Power factor
THD_f	Total harmonic distortion with respect to the fundamental
THD_r	Total harmonic distortion with respect to the true RMS value of the signal.
	Indicator of order to the phases
	Compensation of the resistance of the leads
	Continuity test
	Diode test
	Permanent display (automatic switching off de-activated)
	Spent battery indicator

The display of “**rdy**”, for “ready”, indicates that the device is ready (“Indicator of order of the phases” function).

1.3.2 Measurement capacity exceeded (O.L)

The O.L (Over Load) symbol is displayed when the display capacity is exceeded.

1.4 THE TERMINALS

The terminals are used as follows:

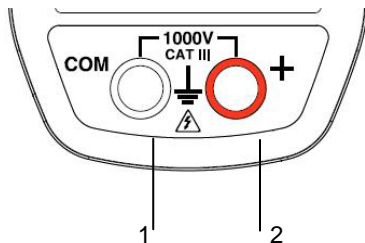

Item	Function
1	Cold terminal (COM)
2	Hot terminal (+)

Figure 5 : the terminals

2 THE KEYS

The keys of the keypad respond differently to short, long, and sustained presses.

The **MAX/MIN PEAK**, **Hz** and **REL** keys provide new functions and allow the detection and acquisition of parameters complementary to the usual elementary measurements.

- Each of these keys can be used independently of the others or in perfect complementarity with them: this makes navigation simple and intuitive for looking up all measurement results.
- It is possible, for example, to look up in turn the MAX, MIN, etc. values of the RMS voltage alone, or else look up in turn all of the MAX (or MIN, or PEAK) values of all power results (W, VA, var, etc.).

In this section, the  icon represents the possible positions of the switch for which the key concerned has some action.







2.1 **HOLD** KEY



This key is used to:

- store and look up the last values acquired specific to each function (V, A, Ω , T°) according to the specific modes previously activated (MAX/MIN); the present display is then maintained while the detection and acquisition of new values continues;

- perform automatic compensation of the resistance of the leads (see also § 3.6.1) ;
- perform an automatic zero correction in $A_{DC}/AC+DC$ et $W_{DC}/AC+DC$ (see also § 3.9.2)

Remark : the key is invalid for the “Indication of order of phases” function.

Successive presses on 		... serve
short	   	<ol style="list-style-type: none"> to store the results of the present measurements to hold the display of the last value displayed to return to normal display mode (the value of each new measurement is displayed)
Long (>2 sec)	A_{DC} A_{AC+DC} W_{DC} W_{AC+DC}	to perform automatic compensation of the zero (see § 3.9.2) <i>Remark :</i> this mode operates if the MAX/MIN/PEAK or HOLD modes (short press) are first deactivated
Sustained		to perform automatic compensation of the resistance of the leads (see 3.6.1)





See also § 2.4.2 and § 2.5.1 for the action  key with the action of the  key and with the action of the  key.



2.2 KEY (SECOND FUNCTION)

This key is used to select the type of measurement (AC, DC, AC+DC) and the second functions marked in yellow next to the relevant positions of the switch.

It can also be used, in the configuration mode, to modify the default value (see §3.4)







Remark: the key is invalid in the MAX/MIN/PEAK, HOLD and Δ REL modes.

Successive presses on 		... serve
short	  	-to select AC, DC or AC+DC. Depending on your choice, the screen displays AC, DC or AC+DC

		-to cycle through the Ω and diode test \rightarrow modes and to return to the continuity test \bullet
		- to reset the measurement process for the "indicator of order of rotation of the phases" function.
Long (>2 sec)		- to display the total three-phase power of a balanced system ($\Sigma 3\Phi$ is displayed). - by pressing again, to return to display of the single-phase power ($\Sigma 3\Phi$ is off)

2.3 KEY

This key is used to backlight the display unit.

Successive presses on 		... serve
	    	-to activate or de-activate the backlighting of the screen

Remark: the backlighting is switched off automatically at the end of 2 minutes.











2.4 KEY

2.4.1 In the normal mode

This key activates detection of the MAX, MIN, PEAK+ and PEAK- values of the measurements made.







Max and Min are the extreme mean values in DC and the extreme RMS values in AC. Peak+ is the maximum instantaneous peak and Peak- the minimum instantaneous peak.

Remark : in this mode, the "automatic switching off" function of the device is automatically de-activated. The  symbol is displayed on the screen.

Successive presses on 		... serve
short	 	-to activate detection of the MAX/MIN/PEAK values -to display the MAX, MIN, PEAK+ or PEAK- value successively -to return to display of the present measurement without exiting from the mode (the values already detected are not erased) <i>Remark:</i> the MAX, MIN, PEAK+, PEAK- symbols are both displayed, but only the symbol of the quantity selected blinks. <i>Example:</i> If MIN has been selected, MIN blinks and MAX, PEAK+, PEAK- are lit steadily.
	 	-to activate detection of the MAX/MIN values -to display the MAX or MIN value successively -to return to display of the present measurement without exiting from the mode (the values already detected are not erased)
long (> 2 sec)	   	to exit from the MAX/MIN/PEAK mode. The values previously recorded are then erased. <i>Remark:</i> if the HOLD function is activated, it is not possible to exit from the MAX/MIN/PEAK mode. The HOLD function must first be de-activated.

Remark : ΔREL function can be used with the functions of the MAX/MIN/PEAK mode.





2.4.2 The MAX/MIN/PEAK mode + activation of the HOLD mode

Successive presses on 		... serve
short	   	to display successively the MAX/MIN/PEAK values detected before the  key was pressed.

Note : the HOLD function does not interrupt the acquisition of new MAX, MIN, PEAK values.

2.4.3 Access to the True-INRUSH mode (set to)

This key allows measurement of the True-Inrush current (starting current, or overcurrent in steady-state operation) for AC or DC current only (not operational in AC+DC).



Successive presses on 		...serves
long (>2 sec)		<p>to enter the True-INRUSH mode</p> <ul style="list-style-type: none"> - "Inrh" is displayed for 3s (the backlighting blinks) - the triggering threshold is displayed for 5s (the backlighting is steady); - "-----" is displayed and the "A" symbol flashes - after detection and acquisition, the inrush current measurement is displayed, after the calculations stage "-----" (backlighting off) <p>Remark: the A symbol flashes to indicate "surveillance" of the signal.</p> <p>to exit from the True-INRUSH mode (return to simple current measurement).</p>
short (<2 sec)		<ul style="list-style-type: none"> - to display the PEAK+ value of the current - to display the PEAK- value of the current - to display the RMS true-Inrush current <p>Remark: the A symbol is displayed steadily during this sequence.</p>





2.5 KEY

This key is used to display the frequency measurements of a signal, of the power, and of the level of harmonics.





Remark : this button is not functional in DC.

2.5.1 The Hz function in the normal model

Successive presses on 		...serves
---	---	-----------

short	 	to display: -the frequency of the signal measured -the present voltage (V) or current (A) measurement
		to display: -the apparent power (VA) - the reactive power (var) - the power factor (PF) - the frequency of the signal - the active power (W)
long		- to enter or exit from the level of harmonics (THD) calculation and display mode
then short		- to select THD _i , THD _r , or the frequency of the fundamental











2.5.2 The Hz function + activation of the HOLD mode

Successive presses on 		...serves
short	 	-to store the frequency -to display successively the stored frequency, then the voltage or the current - to display in turn the stored values of THD _i , then of THD _r , then of the frequency of the fundamental

2.6 KEY

This key is used to display and store the reference value or to display the differential and relative value, in the unit of magnitude measured or in %.

Remark : in phasis rotation mode, the  key is not operating.

Successive presses on 		...serve
short		- to enter the Δ REL mode, to store then display the reference value. The Δ Ref symbol is displayed.
	  	- to display the differential value: - (current value – reference (Δ)) The Δ REL symbol is displayed. - to display the relative value in % <u>current value – reference (Δ)</u> reference (Δ) The Δ REL and % symbols are displayed. - to display the reference. The Δ Ref symbol is displayed - to display the current value. The Δ Ref symbol blinks.
long (>2 sec)	   	to exit from the Δ REL mode

Remark : the “Relative mode Δ REL” function can be used with the functions of the MAX/MIN/PEAK mode.

3 USE

3.1 COMMISSIONING

Insert the battery supplied with the device as follows:

1. Using a screwdriver, unscrew the screw of the battery compartment cover (item 1) on the back of the housing and open it.
2. Place the battery in the compartment (item 2), taking care to get the polarities right.
3. Close the battery compartment cover and screw it to the housing.

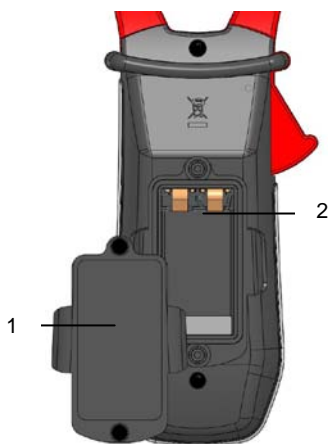

Figure 6 : the battery compartment cover

3.2 STARTING UP THE CLAMP MULTIMETER

The switch is set to OFF. Turn the switch to the function of your choice. The whole display lights (all symbols) for a few seconds (see §1.3), then the screen of the function chosen is displayed. The clamp multimeter is then ready to make measurements.

3.3 SWITCHING THE CLAMP MULTIMETER







The clamp multimeter can be switched off either manually, by setting the switch to OFF, or automatically, after ten minutes with no action on the switch and/or the keys. Thirty (30) seconds before the device is switched off, an audible signal sounds intermittently. To re-activate the device, press any key or turn the switch.

3.4 CONFIGURATION

As a safety measure, and to avoid repeated overloads on the inputs of the device, we recommend performing configuration operations only when the device is disconnected from all dangerous voltages.

3.4.1 Programming of the maximum resistance allowed for a continuity



To program the maximum resistance allowed for a continuity

1. From the OFF position, hold the  key down while turning the switch to , until the "full screen" display ends and a beep is emitted, to enter the configuration mode. The display unit indicates the value below which the buzzer is activated and the  symbol is displayed. The value stored by default is 40Ω. The possible values lie between 1Ω and 599Ω.
2. To change the threshold, press the  key. The right-hand digit flashes: each press on the  key increments it. To shift to the next digit, apply a long press (>2s) to the  key.

To exit from the programming mode, turn the switch to another setting. The detection threshold chosen is stored (emission of a double beep).

3.4.2 De-activation of automatic switching off (Auto Power OFF)

To de-activate automatic switching off:



In the OFF position, hold the  key down while turning the switch to , until the "full screen" display ends and a beep is emitted, to enter the configuration mode. The  symbol is displayed.



When the  key is released, the device is in the voltmeter function in the normal mode.

The return to Auto Power OFF takes place when the clamp is switched back on.

3.4.3 Programming of the current threshold for the True INRUSH measurement

To program the triggering current threshold of the True INRUSH measurement:

1. in the OFF position, hold the  key down while turning the switch to , until the "full screen" display ends and a beep is emitted, to enter the configuration mode. The display unit indicates the percentage overshoot to apply to the measured current to determine the measurement triggering threshold. The value stored by default is 10%, representing 110% of the established current measured. The possible values are 5%, 10%, 20%, 50%, 70%, 100%, 150%, and 200%.



2. To change the threshold, press the  key. The value flashes: each press on the  key displays the next value. To record the chosen threshold, apply a long press (>2s) on the  key. A confirmation beep is emitted.

To exit from the programming mode, turn the switch to another setting. The chosen threshold is stored (emission of a double beep).

Note: The starting current measurement triggering threshold is fixed at 1% of the least sensitive range. This threshold is not adjustable.

3.4.4 Default configuration

To reset the clamp to its default parameters (factory configuration):

In the OFF position, hold the  key down while turning the switch to , until the "full screen" display ends and a beep is emitted, to enter the configuration mode. The "rSt" symbol is displayed.

After 2 s, the clamp emits a double beep, then all of the symbols of the screen are displayed until the  key is released. The default parameters are then restored:

Continuity detection threshold =40Ω

True Inrush triggering threshold =10%

3.5 VOLTAGE MEASUREMENT (V)

To measure a voltage, proceed as follows :

1. Set the switch to ;
2. Connect the black lead to the **COM** terminal and the red lead to "+".
3. Place the test probes or the crocodile clips on the terminals of the circuit to be measured. The device selects AC or DC automatically according to which measured value is larger. The AC or DC symbol lights in blinking mode.

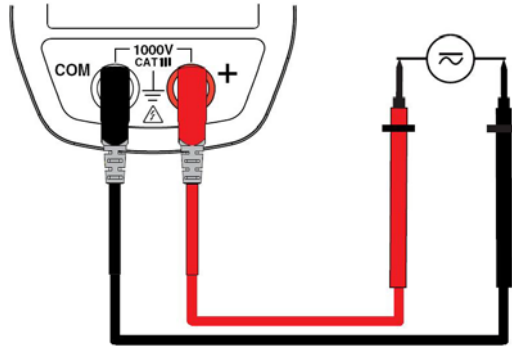

To select AC, DC or AC+DC manually, press the yellow key to reach the desired choice. The symbol corresponding to the choice made then lights in fixed mode.



The measured value is displayed on the screen.

3.6 CONTINUITY TEST

Warning : Before performing the test, make sure that the circuit is off and any capacitors have been discharged.

1. Set the switch to ; the  symbol is displayed ;
2. Connect the black lead to the COM terminal and the red lead to «+».
3. Place the test probes or the crocodile clips on the terminals of the circuit or component to be tested.

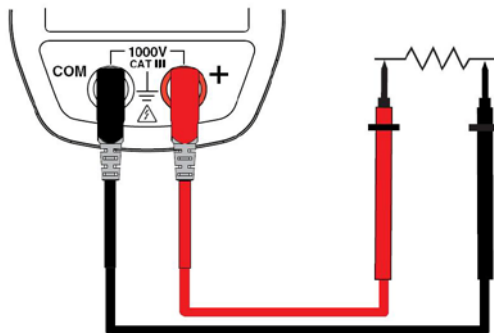

An audible signal is emitted if there is continuity, and the measured value is displayed on the screen.

3.6.1 Automatic compensation of the resistance of the leads

Warning : before the compensation is executed, the MAX/MIN and HOLD modes must be de-activated.

To perform automatic compensation of the resistance of the leads, proceed as follows:

1. Short-circuit the leads connected to the device.
2. Hold the **HOLD** key down until the display unit indicates the lowest value. The device measures the resistance of the leads.
3. Release the **HOLD** key. The correction and the $\rightarrow 0 \leftarrow$ symbole are displayed. The value displayed is stored.

Remark : the correction value is stored only if it is $\leq 2 \Omega$. Above 2Ω , the value displayed blinks and is not stored.

3.7 RESISTANCE MEASUREMENT Ω

Warning : Before making a resistance measurement, make sure that the circuit is cold and any capacitors have been discharged.

1. Set the switch to **Ω** and press the **ON/OFF** key. The Ω symbol is displayed;
2. Connect the black lead to the **COM** terminal and the red lead to **+ ;**
3. Place the test probes or the crocodile clips on the terminals of the circuit or component to be measured ;

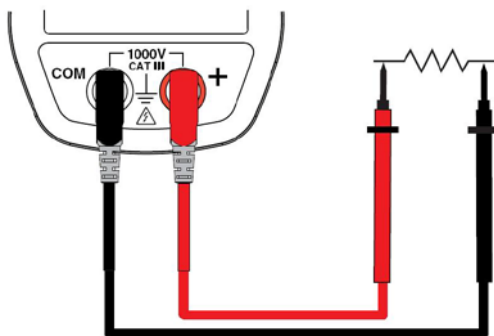



The measured value is displayed on the screen

Remark : to measure low resistance values, first carry out the compensation of the resistance of the leads (see § [3.6.1](#)).

3.8 DIODE TEST $\rightarrow+$

Warning: Before performing the diode test, make sure that the circuit is cold and any capacitors have been discharged.

1. Set the switch to  and press the  key twice. The $\rightarrow+$ symbol is displayed.
2. Connect the black lead to the COM terminal and the red lead to «+».
3. Place the test probes or the crocodile clips on the terminals of the component to be tested.

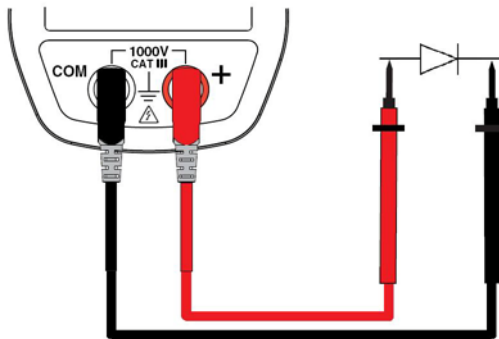

The measured value is displayed on the screen.

3.9 CURRENT MEASUREMENT (A)



The jaws are opened by pressing the trigger on the body of the device. The arrow on the jaws of the clamp (see the diagram below) must point in the presumed direction of flow of the current, from the generator to the load. Make sure that the jaws have closed correctly.

Remark: the measurement results are optimal when the conductor is centred in the jaws (aligned with the centring marks).

The device automatically selects AC or DC according to which measured value is larger. The AC or DC symbol blinks.

3.9.1 AC measurement

For an AC current measurement, proceed as follows:

1. Set the switch to  and select AC by pressing the  key. The AC symbol is displayed.
2. Encircle only the conductor concerned with the clamp ;

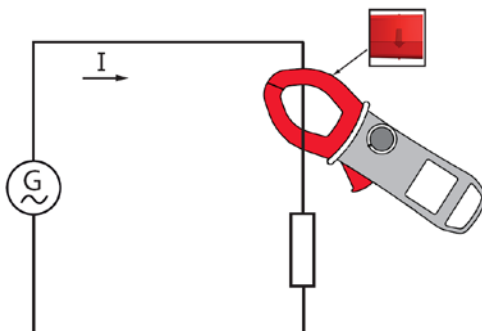

The measured value is displayed on the screen.

3.9.2 DC or AC+DC measurement

To measure the DC or AC+DC current, if the display unit does not indicate "0", first correct the DC zero as follows:

Step 1 : to correct the DC zero

Important : The clamp must not be closed on the conductor during the DC zero correction. Hold the clamp in the same position during the whole procedure so that the correction value will be exact.

Press the **HOLD** key until the device emits a double beep and displays a value near "0". The correction value is stored until the clamp is powered down.

Remark : the correction is effected only if the value displayed is $< \pm 6$ A, otherwise the value displayed blinks and is not stored. The clamp must be recalibrated (see §5.3)

Step 2 : to make a measurement

1. The switch is set to **A**. Select DC or AC+DC by pressing the yellow key until the desired choice is reached.
2. Apply the clamp to only the conductor concerned.

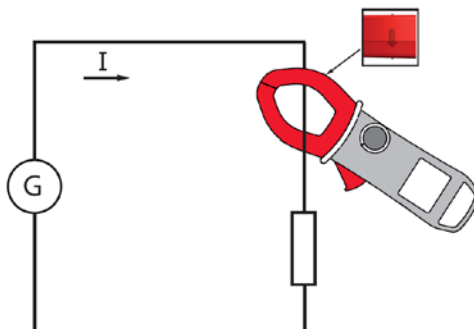

The measurement is displayed on screen.

3.10 STARTING CURRENT OR OVERCURRENT (TRUE INRUSH) MEASUREMENT

Remark : the measurement can be made only in AC or DC mode (AC+DC mode disabled)

To measure a starting current or overcurrent, proceed as follows:

1. Set the switch to **A** correct the DC zero (§ 3.9.2), then apply the clamp around the single conductor concerned.
2. Effect a long press on the **MAX/MIN PEAK** key. The InRh symbol is displayed, then the triggering threshold. The clamp then awaits detection of the True-Inrush current. "-----" is displayed and the "A" symbol flashes.
3. After detection and acquisition for 100 ms, the RMS value of the True-Inrush current is displayed, along with the PEAK+/PEAK- values subsequently.
4. A long press on the **MAX/MIN PEAK** key or a change of function leads to exiting from the True-Inrush mode.

Remark : the triggering threshold in A is 6A if the initial current is zero (starting of installation); it is that set in the configuration (see §3.4.3) for an established current (overload in a installation).

3.11 POWER MEASUREMENTS W, VA, VAR AND PF

This measurement is possible en single-phase or in balanced three-phase.

Reminder : in DC or AC+DC power measurement, first correct the DC zero in current (see § 3.9.2, step 1)

For the power factor (PF) and the powers VA and var, the measurement is possible only in AC or AC+DC.

3.11.1 Measurement of single-phase power

1. Set the switch to $\frac{W}{V}$ and select VA, var, or PF by pressing the **Hz** key until the desired choice is reached;
2. The device automatically displays AC+DC. To select AC, DC, or AC+DC, press the **yellow** key until the desired choice is reached.
3. Connect the black lead to the **COM** terminal and the red lead to "+";
4. Place the test probes or the crocodile clips of the black lead on the neutral (N), then those of the red lead on the L phase.
5. Clamp only the corresponding conductor, respecting the direction;

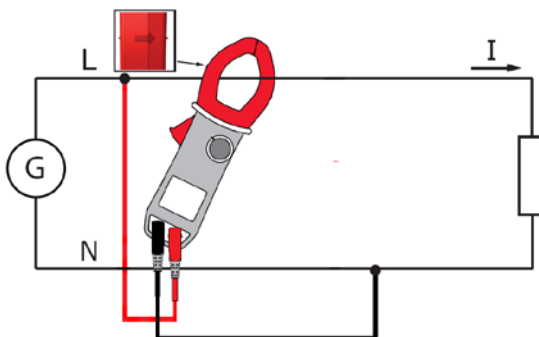

The measurement is displayed on screen.

3.11.2 Balanced three-phase power measurement

1. Set the switch to $\frac{W}{V}$ and select VA, var, or PF by pressing the **Hz** key until the desired choice is reached
2. Press the yellow key until the $\Sigma 3\Phi$ symbol is displayed.
3. The device automatically displays AC+DC. To select AC, DC, or AC+DC, press the yellow **yellow** key until the desired choice is reached.
4. Connect the black lead to the **COM** terminal and the red lead to "+";
5. Connect the leads and the clamp to the circuit as follows:

If the red lead is connected...	...and the black lead is connected	...then the clamp is on the conductor
To the L1 phase	to the L2 phase	of the L3 phase
To the L2 phase	to the L3 phase	of the L1 phase
To the L3 phase	to the L1 phase	of the L2 phase

Reminder : the arrow on the jaws of the clamp (see the diagram below) must point in the presumed direction of flow of the current from the source (producer) to the load (consumer)

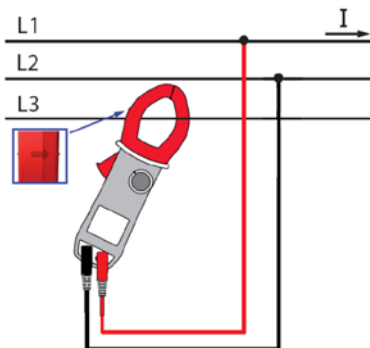

The measurement is displayed on screen.



Remark : You can also measure the three-phase power on a balanced 4-wire network by proceeding in the same way, or by proceeding as for the measurement on a single-phase network, then multiplying the value found by three.

3.12 “DIRECTION OF ROTATION OF THE PHASES” OR “ORDER OF THE PHASES” MODE

This mode is used to determine the order of the phases of a three-phase network by the "2-wire" method.

To determine the order of the phases, proceed as follows:

Step 1: determination of a "reference" period:

1. Set the switch to . The **rdy** symbol is displayed; the device is ready for the first phase order determination measurement;
2. Connect the black lead with crocodile clip to the **COM** terminal and the red lead with test probe to "+";
3. Connect the crocodile clip to the presumed L1 phase and apply the red test probe to the presumed L2 phase;
4. Press the yellow  key. The ref symbol blinks on the screen. The instrument is ready to determine the reference period. When the reference period has been determined, an audible signal sounds and the ref and  symbols are displayed.

Remark : if the reference period has not been determined, the device emits a beep and displays the "Err Hz" or "ErrV" message. The  symbol flashes, then the "rdy" message is displayed on the screen. Repeat the procedure from 4.

Step 2: determination of a "measurement" period:

Within the next 10 seconds, apply the test probe to the presumed L3 phase. The "MEAS" indication then blinks on the display unit as soon as the L2 phase is disconnected; the device is in the calculation phase.

Remark: if the measurement period has not been determined, the device emits a beep and displays the "Err Hz" or "ErrV" message, then "rdy". Repeat the procedure from 4.

Result: when the order of the phases has been determined, the device emits a beep and the indication of order of the phases is displayed on the screen, as follows:

- 0.1.2.3 when the direction of rotation is direct. The "0" symbol blinks and turns clockwise;
- 0.3.2.1 when the direction of rotation is reversed. The "0" symbol blinks and turns anticlockwise.

Remark: if the order of the phases has not been determined, the device emits a beep and displays the "Err" message. Repeat the procedure from 4.

3.13 FREQUENCY MEASUREMENT (HZ)

The frequency measurement is available in **V**, **W** and **A** for AC and AC+DC quantities. The measurement is based on a count of the passages of the signal through zero (positive-going edges).

3.13.1 Frequency measurement in voltage

To measure the frequency in voltage, proceed as follows:

1. Set the switch to **V_~** and press the **Hz** key. The Hz symbol is displayed.
2. Select AC or AC+DC by pressing the yellow key until the desired choice is reached.
3. Connect the black lead to the **COM** terminal and the red lead to "+".
4. Place the test probes or the crocodile clips on the terminals of the circuit to be measured.

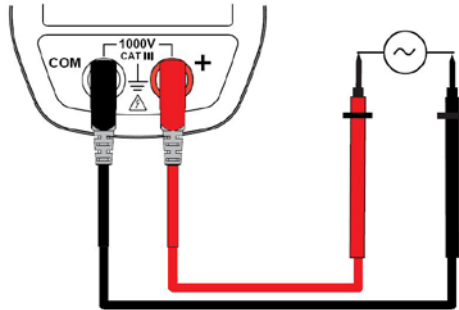

The measured value is displayed on the screen.

3.13.2 Frequency measurement in current

1. Set the switch to **A** and press the **Hz** key. The **Hz** symbol is displayed.
2. Select AC or AC+DC by pressing the yellow key until the desired choice is reached.
3. Encircle only the conductor concerned with the clamp.

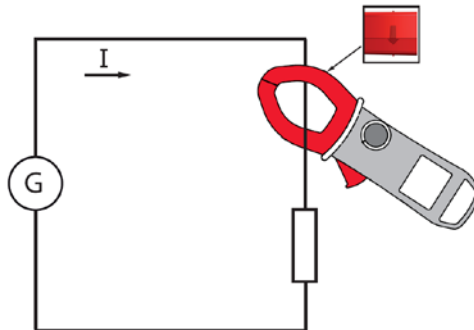

The measured value is displayed on the screen.

3.13.3 Measurement of frequency in power

In the single-phase AC or AC+DC Power (W) setting, it is possible to display the frequency of the voltage of the signal on the terminals.

In the balanced three-phase AC or AC+DC Power (W) setting, it is possible to display the frequency of the phase-to-phase voltage of the signal on the terminals.

3.14 MEASUREMENT OF THE LEVEL OF HARMONICS (THD) AND OF THE FREQUENCY OF THE FUNDAMENTAL (NETWORK)

The device measures the total harmonic distortion with respect to the fundamental (THD_f) and the total harmonic distortion with respect to the true RMS value of the signal (THD_r) in voltage and in current. Similarly, it determines the frequency of the fundamental by digital filtering and FFT, for network frequencies of 50, 60, 400, and 800Hz..

3.14.1 Measurement of the THD and of the frequency of the fundamental in voltage

1. Set the switch to **V_~** and press and hold (>2s) the **Hz** key. The **THD_f** symbol is displayed. To select **THD_r**, press the **Hz** key again. The **THD_r** symbol is displayed. To select the frequency of the fundamental, press the **Hz** key again. The **Hz** symbol is displayed.
2. Connect the black lead to the **COM** terminal and the red lead to **+**;
3. Place the test probes or the crocodile clips on the terminals of the circuit to be measured;

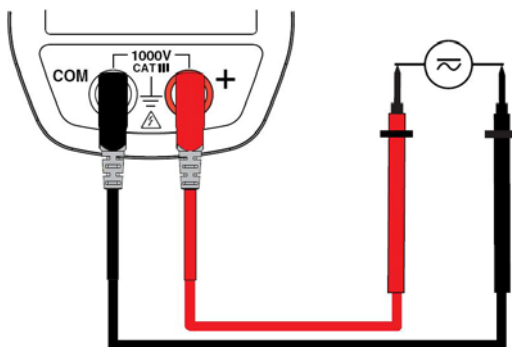

The measurement is displayed on screen.

3.14.2 Measurement of the THD and of the frequency of the fundamental in current

1. Set the switch to **A_~** and press and hold (>2s) the **Hz** key. The **THD_f** symbol is displayed. To select **THD_r**, press **Hz** again. The **THD_r** symbol is displayed. To select the frequency of the fundamental, press the **Hz** key again. The **Hz** symbol is displayed.
2. Apply the clamp to only the conductor concerned.

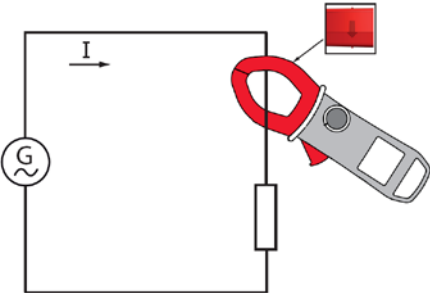

The measurement is displayed on screen.

4 CHARACTERISTICS

4.1 REFERENCE CONDITIONS

Quantities of influence	Reference conditions
Temperature:	23°C ±2°C
Relative humidity:	45% to 75%
Supply voltage:	9.0V ±0.5V
Frequency range of the applied signal:	45–65Hz
Sine wave:	pure
Peak factor of the applied alternating signal:	$\sqrt{2}$
Position of the conductor in the clamp:	centred
Adjacent conductors:	none
Alternating magnetic field:	none
Electric field:	none

4.2 CHARACTERISTICS UNDER THE REFERENCE CONDITIONS

The uncertainties are expressed in ± (x% of the reading (R) + y points (pt)).

4.2.1 DC voltage measurement

Measurement range	0.00 V to 59.99 V	60.0 V to 599.9 V	600 V to 1000 V (1)
Specified measurement range	0 to 100% of the measurement range		
Uncertainties	from 0.00V to 5.99V ±(1% R + 10 pt) from 6.00V to 59.99V ±(1% R + 3 pt)	±(1% R + 3 pt)	
Resolution	0.01V	0.1V	1V
Input impedance	10MΩ		

Note (1) - The display indicates "+OL" above +2000V and "-OL" below - 2000V in REL mode

- Above 1000V, a repetitive beep indicates that the voltage being measured is greater than the safety voltage for which the device is guaranteed. The display indicates "OL"

4.2.2 AC voltage measurement

Measurement range	0.15 V to 59.99 V	60.0 V to 599.9 V	600 V to 1000V RMS 1400V peak (1)
Specified measurement range (2)	0 to 100% of the measurement range		
Uncertainties	from 0.15V to 5.99V $\pm (1\% R + 10 \text{ pt})$ from 6.00V to 59.99V $\pm (1\% R + 3 \text{ pt})$	$\pm (1\% R + 3 \text{ pt})$	
Resolution	0.01V	0.1V	1V
Input impedance	10M Ω		

Note (1) - The display indicates "OL" above 1000V (1400V in PEAK mode).

- Above 1000V, a repetitive beep indicates that the voltage being measured is greater than the safety voltage for which the device is guaranteed. The display indicates "OL".
- Bandwidth in AC = 3 kHz

Note (2) Any value between zero and the min. threshold of the measurement range (0.15V) is forced to "----" on the display.

4.2.3 AC+DC voltage measurement

Measurement range (2)	0.15 V to 59.99 V	60.0 V to 599.9 V	600 V to 1000V RMS (1) 1400V peak
Specified measurement range	0 to 100% of the measurement range		
Uncertainties	from 0.15V to 5.99V $\pm (1\% R + 10 \text{ pt})$ from 6V to 59.99V $\pm (1\% R + 3 \text{ pt})$	$\pm (1\% R + 3 \text{ pt})$	
Resolution	0.01V	0.1V	1V
Input impedance	10M Ω		

- Note (1)** - The display indicates "OL" above 1000V (1400V in PEAK mode).
 - Above 1000V (DC or RMS), a repetitive beep indicates that the voltage being measured is greater than the safety voltage for which the device is guaranteed.
 - Bandwidth in AC = 3 kHz

- Note (2)** - Any value between zero and the min. threshold of the measurement range (0.15V) is forced to "----" on the display.

Specific characteristics in MAX/MIN mode in voltage (from 10Hz to 1kHz in AC and AC+DC, and from 0.30V):

- Uncertainties: add 1% R to the values in the tables above.
- Capture time of the extrema: approximately 100ms.

Specific characteristics in PEAK mode in voltage (from 10Hz to 400 Hz in AC and AC+DC):

- Uncertainties: add 1.5% R to the values in the tables above.
- PEAK capture time: 1ms min. to 1.5ms max.

4.2.4 DC current measurement

Measurement range (2)	0.00 A to 59.99 A	60.0 A to 599.9 A	600 A to 900 A (1)
Specified measurement range	0 to 100% of the measurement range		
Uncertainties (2) (zero corrected)	$\pm (1\% R + 10 \text{ pt})$	$\pm (1\% R + 3 \text{ pt})$	
Resolution	0.01A	0.1A	1A

Note (1) - The display indicates "+OL" above 1800A and "-OL" below -1800A in REL mode. The "-" and "+" signs are managed (polarity).

Note (2) - The residual current at zero depends on the remanence; It can be corrected by the "DC zero" function of the HOLD key.

4.2.5 AC current measurement

Measurement range (2)	0.15 A to 59.99 A	60.0 A to 599.9 A	600 A (1)
Specified measurement range	0 to 100% of the measurement range		
Uncertainties	± (1% R + 10 pt)		± (1% R + 3 pt)
Resolution	0.01A	0.1A	1A

Note (1) - The display indicates "OL" above 900A in PEAK mode. The "-" and "+" signs are not managed.

- Bandwidth in AC = 3 kHz

Note (2) - Any value between zero and the min. threshold of the measurement range (0.15V) is forced to "----" on the display.

- Residual current at zero <150mA.

4.2.6 AC+DC intensity measurement

Measurement range (2)	0.15 A to 59.99 A	60.0 A to 599.9 A	AC: 600 A DC or PEAK: 600 A to 900 A (1)
Specified measurement range	0 to 100% of the measurement range		
Uncertainties (2) (zero corrected)	± (1% R+10 pt)	± (1% R + 3 pt)	
Resolution	0.01A	0.1A	1A

Note (1) - In DC, the display indicates "+OL" above +1800A and "+-OL" above -1800A in REL mode. The "-" and "+" signs are managed (polarity).

- In AC and AC+DC, the display indicates "+OL" above 900A in PEAK mode. The "-" and "+" signs are not managed.

- Bandwidth in AC = 3 kHz

Note (2) - In AC, any value between zero and the min. threshold of the measurement range (0.15A) is forced to "----" on the display.

- Residual current at zero:

- In DC: depends on the remanence. Can be corrected by the "DC zero" function of the HOLD key
- In AC: <150mA

Specific characteristics in MAX/MIN mode in current (from 10Hz to 1kHz in AC and AC+DC, and from 0.30 A):

- Uncertainties: add \pm (1% R) to the values in the tables above.
- Capture time of the extrema: approximately 100ms.

Specific characteristics in PEAK mode in current (from 10Hz to 400 Hz in AC and AC+DC):

- Uncertainties: add \pm (1.5% R+0.5A) to the values in the tables above.
- PEAK capture time: 1ms min. to 1.5ms max.

4.2.7 True-Inrush measurement

Measurement range	6 A to 600 A AC	6 A to 900 A DC
Specified measurement range	0 to 100% of the measurement range	
Uncertainties	\pm (5% R + 5 pt)	
Resolution	1 A	

Specific characteristics in PEAK mode in True-Inrush (from 10Hz to 400 Hz in AC):

- Uncertainties: add \pm (1.5% R+0.5A) to the values in the tables above.
- PEAK capture time: 1ms min. to 1.5ms max.

4.2.8 Continuity measurement

Measurement range	0.0 Ω to 599.9 Ω
Open-circuit voltage	\leq 3,6 V
Measurement current	550 μ A
Uncertainties	\pm (1% R +5 pt)
Buzzer triggering threshold	Adjustable from 1 Ω to 599 Ω (40 Ω is the default)

4.2.9 Resistance measurement

Measurement range (1)	0.0 Ω to 599.9 Ω	600 Ω to 5999 Ω	6.00 k Ω to 59.99 k Ω
Specified measurement range	1 to 100% of the measurement range	0 to 100% of the measurement range	
Uncertainties	\pm (1% R +5 pt)		

Resolution	0.1Ω	1Ω	10Ω
Open-circuit voltage	≤ 3,6 V		
Measurement current	550μA	100μA	10μA

Note (1) - Above the maximum display value, the display unit indicates "OL".
 - The "-" and "+" signs are not managed.

Specific characteristics in MAX/MIN mode:

- Uncertainties: add 1% R to the values of the table above.
- Capture time of the extrema: approximately 100ms.

4.2.10 Diode test

Measurement range	0.000V to 3.199V DC
Specified measurement range	1 to 100% of the measurement range
Uncertainties	± (1% R + 3 pt)
Resolution	0.001V
Measurement current	0.55 mA
Indication: junction reversed or open-circuit	Display of "OL" when the measured voltage >3.199V

 **Note** : The "-" sign is disabled for the diode test function.

4.2.11 Active DC power measurements

Measurement range (2)	0 W to 5999 W	6.00 kW to 59.99 kW	60.0 kW to 599.9 kW	600 kW to 900 kW (1)
Specified measurement range	1 to 100% of the measurement range	0 to 100% of the measurement range		
Uncertainties (3)	± (2% R +10 pt)	± (2% R +3 pt)		
Resolution	1W	10W	100W	1,000W

Note (1) - Display of O.L or ± O.L
 - Above 900kW in single-phase (1000V x 900A).
 - Above ±1800kW, in REL mode.

Note (2) - Any applied voltage greater than 1000V causes the emission of an intermittent alarm beep to report a dangerous overload.

Note (3) - The measurement result may be perturbed by an instability linked to the current measurement (approximately 0.1A).

Example: for a power measurement made at 10A, the instability of the measurement will be 0.1A/10A or 1%.

4.2.12 Active AC power measurements

Measurement range (2) (4)	5 W to 5999 W	6.00 kW to 59.99 kW	60.0 kW to 599.9 kW	600 kW (1)
Specified measurement range	1 to 100% of the measurement range	0 to 100% of the measurement range		
Uncertainties (3) (7)	± (2% R +10 pt)	± (2% R +3 pt)		
Resolution	1W	10W	100W	1000W

Note (1) - Display of O.L

- Above 600kW in single-phase (1000V x 600A).

- Bandwidth in AC in voltage = 3 kHz, in current = 3 kHz

Notes (2) and (3) of the previous § apply.

Note (4) - Any power measured less than 5W is regarded as zero and causes the display of dashes "----"

- If the voltage is less than 0.15V or if the current is less than 0.15A, the power measured is regarded as zero and causes the display of dashes "----"

Note 5 - The active powers are positive for power consumed and negative for power generated.

Note 6 - The signs of the active and reactive powers and power factor are defined by the four-quadrant rule below:

- The diagram below sums up the signs of the power as a function of the phase angle between U and I:

Quadrant 1 : Active power P sign + (power consumed)

Quadrant 2 : Active power P sign - (power generated)

Quadrant 3 : Active power P sign - (power generated)

Quadrant 4 : Active power P sign + (power consumed)

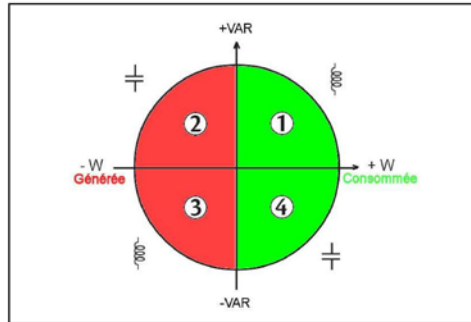

Note (7) - In balanced three-phases, with deformed signals (THD and harmonics), uncertainties are guaranteed since $\Phi > 30^\circ$. Additional errors are following, depending of THD :

Add +1% for $10\% < THD < 20\%$

Add +3% for $20\% < THD < 30\%$

Add +5% for $30\% < THD < 40\%$

4.2.13 Active AC+DC power measurements

Measurement range (2) (4)	5 W to 5999 W	6.00 kW to 59.99 kW	60.0 kW to 599.9 kW	600 kW to 900 kW (1)
Specified measurement range	1 to 100% of the measurement range	0 to 100% of the measurement range		
Uncertainties (3) (7)	$\pm (2\% R + 10 \text{ pt})$	$\pm (2\% R + 3 \text{ pt})$		
Resolution	1W	10W	100W	1000W

Note (1) - Display of O.L

- Above 900kW in single-phase (1000V x 900A).

- Bandwidth in AC in voltage = 3 kHz, in current = 3 kHz

Notes (2), (3), (4), 5, 6 and (7) of the previous § apply.

4.2.14 Measurement of apparent AC power

Measurement range (2) (4)	5 VA to 5999 VA	6.00 kVA to 59.99 kVA	60.0 kVA to 599.9 kVA	600 kVA (1)
Specified measurement range	1 to 100% of the measurement range	0 to 100% of the measurement range		
Uncertainties (3)	$\pm (2\% R + 10 \text{ pt})$	$\pm (2\% R + 3 \text{ pt})$		
Resolution	1VA	10VA	100VA	1000VA

Note (1) - Display of O.L

- Above 600 kVA in single-phase (1000 V x 600 A).
- Bandwidth in AC in voltage = 3 kHz, in current = 3 kHz

Notes (2), (3) and (4) of the previous § apply.

4.2.15 Measurement of apparent AC+DC power

Measurement range (2) (4)	5 VA to 5999 VA	6.00 kVA to 59.99 kVA	60.0 kVA to 599.9 kVA	600 kVA to 900 kVA (1)
Specified measurement range	1 to 100% of the measurement range	0 to 100% of the measurement range		
Uncertainties (3)	$\pm (2\% R + 10 \text{ pt})$	$\pm (2\% R + 3 \text{ pt})$		
Resolution	1VA	10VA	100VA	1000VA

Note (1) - Display of O.L

- Above 900 kVA in single-phase (1000 V x 900 A).
- Bandwidth in AC in voltage = 3 kHz, in current = 3 kHz

Notes (2), (3) and (4) of the previous § apply.

4.2.16 Measurement of reactive AC power

Measurement range (2) (4)	5 var to 5999 var	6.00 kvar to 59,99 kvar	60.0 kvar to 599.9 kvar	600 kvar (1)
Specified measurement range	1 to 100% of the measurement range	0 to 100% of the measurement range		
Uncertainties (3) (8)	± (2% R +10 pt)	± (2% R +3 pt)		
Resolution	1 var	10 var	100 var	1000 var

Note (1) - Display of O.L

- Above 600 kvar in single-phase (1000 V x 600 A).
- Bandwidth in AC in voltage = 3 kHz, in current = 3 kHz

Notes (2), (3) and (4) of the previous § apply.

Note 5 - In single-phase, the sign of the reactive power is determined by the phase lead or lag between the U and I signs, while in balanced three-phase, it is determined by the calculation on the samples.

Note 6 - Signs of reactive powers according to the four-quadrant rule (§4.2.12):

- Quadrant 1 : Reactive power Q sign +
- Quadrant 2 : Reactive power Q sign +
- Quadrant 3 : Reactive power Q sign -
- Quadrant 4 : Reactive power Q sign -

Note (8) - In single phase, with deformed signals (THD and harmonics), uncertainties are guaranteed since $\Phi > 30^\circ$. Additional errors are following, depending of THD :

- Add +1% for 10% < THD < 20%
- Add +3% for 20% < THD < 30%
- Add +5% for 30% < THD < 40%

4.2.17 Measurement of reactive AC+DC power

Measurement range (2) (4)	5 var to 5999 var	6.00 kvar to 59.99 kvar	60.0 kvar to 599.9 kvar	600 kvar to 900 kvar (1)
Specified measurement range	1 to 100% of the measurement range	0 to 100% of the measurement range		
Uncertainties (3) (8)	± (2% R +10 pt)	± (2% R +3 pt)		
Resolution	1 var	10 var	100 var	1000 var

Note (1) - Display of O.L

- Above 900 kvar in single-phase (1000 V x 900 A).
- Bandwidth in AC in voltage = 3 kHz, in current = 3 kHz

Notes (2), (3), (4), 5, 6 and (8) of the previous § apply.

Specific characteristics in MAX/MIN mode in power (from 10Hz to 1kHz):

- Uncertainties: add 1% R to the values in the tables above.
- Capture time: approximately 100ms

4.2.18 Calculation of the power factor

Measurement range (1)	-1.00 to +1.00	
Specified measurement range	0 to 50% of the measurement range	50 to 100% of the measurement range
Uncertainties (7)	± (3% R +3 pt)	± (2% R +3 pt)
Resolution	0.01	

Note (1) - If one of the terms in the calculation of the power factor is displayed as "OL", or forced to zero, the display of the power factor is an indeterminate value "----".

Note (7) of the previous § apply.

Note 9 - Sign of the power factor according to the four-quadrant rule (§4.2.12):

Quadrant 1 :	Power factor PF	sign + (inductive system)
	Cos Φ	sign +
Quadrant 2 :	Power factor PF	sign - (capacitive system)
	Cos Φ	sign -
Quadrant 3 :	Power factor PF	sign + (inductive system)
	Cos Φ	sign -
Quadrant 4 :	Power factor PF	sign - (capacitive system)
	Cos Φ	sign +

Specific characteristics in MAX/MIN mode (from 10Hz to 1kHz):

- Uncertainties: add 1% R to the values in the tables above.
- Capture time: approximately 100ms.

4.2.19 Frequency measurements

4.2.19.1 Characteristics in voltage

Measurement range (1)	5.0 Hz to 599.9 Hz	600 Hz to 5999 Hz	6.00 kHz to 19.99 kHz
Specified measurement range	1 to 100% of the measurement range	0 to 100% of the measurement range	
Uncertainties	$\pm (0.4\% R + 1 \text{ pt})$		
Resolution	0.1Hz	1Hz	10Hz

4.2.19.2 Characteristics in current

Measurement range (1)	5.0 Hz to 2999 Hz
Specified measurement range	1 to 100% of the measurement range
Uncertainties	$\pm (0.4\% R + 1 \text{ pt})$
Resolution	0.1Hz

Note (1) in MAX/MIN mode, the operating range is limited to 1kHz.

- If the level of the signal is too low (<10% of the range, or $U < 10V$ or $I < 10A$) or if the frequency is less than 5Hz, the device cannot determine the frequency and displays dashes "----".

Specific characteristics in MAX/MIN mode (from 10Hz to 1kHz):

- Uncertainties: add 1% R to the values of the table above.
- Capture time of the extrema: approximately 100ms.

4.2.20 Characteristics in THDr

Measurement range	0.0 – 100%
Specified measurement range	0 to 100% of the measurement range
Uncertainties	$\pm (5\% R \pm 2 \text{ pts})$ in voltage $\pm (5\% R \pm 5 \text{ pts})$ in current
Resolution	0.1%

4.2.21 Characteristics in THDf

Measurement range	0.0 – 1000%
Specified measurement range	0 to 100% of the measurement range
Uncertainties	$\pm (5\% R \pm 2 \text{ pts})$ in voltage $\pm (5\% R \pm 5 \text{ pts})$ in current
Resolution	0.1%

 **Note** : - The display is "----" if the input signal is too low ($U < 5V$ or $I < 6A$) or if the frequency is less than 5Hz.

Specific characteristics in MAX/MIN mode in THD (from 10Hz to 1kHz):

- Uncertainties: add 1% R to the values in the tables above.
- Capture time of the extrema: approximately 100ms

4.2.22 Indication of order of the phases

Frequency range	47Hz to 400Hz
Acceptable voltage range	50V to 1,000V
Duration of acquisition of the reference period	≤500ms
Duration of validity of the reference period information	approximately 10s at 50Hz approximately 2s to 400Hz
Duration of acquisition of the measurement period + display of the order of the phases	≤500ms
Acceptable phase unbalance	±10
Acceptable amplitude unbalance	20%
Acceptable level of harmonics in voltage	10%

4.3 ENVIRONMENTAL CONDITIONS

Environmental conditions	in use	in storage
Temperature	-20 °C to + 55 °C	-40 °C to + 70°C
Relative humidity (RH):	≤90% at 55°C	≤90% up to 70° C

4.4 CHARACTERISTICS OF CONSTRUCTION

Housing:	Rigid polycarbonate shell with moulded elastomer covering Polycarbonate
Jaws:	Opening: 34 mm Clamping diameter: 34 mm
Screen:	LCD display unit Blue backlighting Dimension: 28 x 43.5 mm
Dimension:	H-222 x W-78 x D-42 mm
Weight:	340g (with the battery)



4.5 POWER SUPPLY

Batter:	1 x 9 V LF22
Mean life:	>120 hours (without backlighting)
Duration of operation before automatic switching off:	After 10 minutes without action on the switch and/or keys

4.6 COMPLIANCE WITH INTERNATIONAL STANDARDS

Electric safety:	Compliant with standards IEC-61010-1, IEC-61010-2-30, and IEC-61010-2-32: 1000V CAT-III or 600V CAT IV.
Electromagnetic compatibility:	Compliant with standard EN-61326-1 Classification: residential environment
Mechanical strength:	Free fall: 2m (in accordance with standard IEC-68-2-32)
Level of protection of the housing:	IP40 (per standard IEC-60529)

4.7 VARIATIONS IN THE DOMAIN OF USE

Quantity of influence	Range of influence	Quantity influenced	Influence	
			Typical	MAX
Temperature	-20...+55°C	V AC	-	0,1%R/10°C
		V DC	0,1%R/10°C	0,5%R/10°C + 2pts
		A	1%R/10°C	1,5%R/10°C + 2pts
		Ω 	-	0,1%R/10°C + 2 pts
		W AC	-	0,2%R/10°C + 1°C
		W DC	0,15%R/10°C	0,3%R/10°C + 2 pts
Humidity	10%...90%HR	V	≤ 1 pt	0,1%R + 1 pt
		A	-	0,1%R + 2 pts
		Ω 	0,2%R	0,3%R + 2 pts
		W	0,25%R	0,5%R + 2 pts
Frequency	10 Hz...1 kHz	V	1%R + 1 pt	1%R + 1 pt
	1 kHz...3 kHz		8%R + 1 pt	9%R + 1 pt
	10 Hz...400 Hz	A	1%R + 1 pt	1%R + 1 pt
	400 Hz...3 kHz		4%R + 1 pt	5%R + 1 pt
Position of the conductor in the jaws ($f \leq 400$ Hz)	Any position on the internal perimeter of the jaws	A-W	2%R	4%R + 1 pt
Adjacent conductor carrying a current of 150 A DC or RMS	Conductor touching the external perimeter of the jaws	A-W	30 dB	20 dB
Conductor enclosed by the clamp	0-500 A DC or RMS	V	< 1 pt	1 pt
Application of a voltage of the clamp	0-1000 V DC or RMS	A-W	< 1 pt	1 pt
Peak factor	1,4 to 3,5 limited to 900 A peak 1400 V peak	A (AC-AC+DC)	1%R	3%R + 1 pt
		V (AC-AC+DC)	1%R	3%R + 1 pt

5 MAINTENANCE

The instrument has no parts that can be replaced by personnel who are not trained and approved. Any non-approved repair or other work, or replacement of a part by an "equivalent", may severely compromise safety.

5.1 CLEANING

- Disconnect everything connected to the device and set the switch to OFF.
- Use a soft cloth moistened with soapy water. Rinse with a damp cloth and dry quickly using a dry cloth or forced air.
- Dry perfectly before putting back into use.

5.2 REPLACEMENT OF THE BATTERY

The  symbol indicates that the battery is spent. When this symbol appears on the display unit, the battery must be replaced. The measurements and specifications are no longer guaranteed.

To replace the battery, proceed as follows:

1. Disconnect the measurement leads from the input terminals.
2. Set the switch to OFF.
3. Use a screwdriver to unscrew the screw securing the battery compartment cover to the back of the housing and open the cover (see §3.1).
4. Replace the battery (see §3.1).
5. Close the cover and screw it to the housing.

5.3 METROLOGICAL CHECK

Like all measuring or testing devices, the instrument must be checked regularly. This instrument should be checked at least once a year. For checks and calibrations, contact one of our accredited metrology laboratories (information and contact details available on request), at our Chauvin Arnoux subsidiary or the branch in your country.

5.4 REPAIR

For all repairs before or after expiry of warranty, please return the device to your distributor.

6 WARRANTY

Except as otherwise stipulated, our warranty is valid for three years starting from the date on which the equipment was sold. Extract from our General Conditions of Sale provided on request.

The warranty does not apply in the following cases:

- Inappropriate use of the equipment or use with incompatible equipment;
- Modifications made to the equipment without the explicit permission of the manufacturer's technical staff;
- Work done on the device by a person not approved by the manufacturer;
- Adaptation to a particular application not anticipated in the definition of the equipment or not indicated in the user's manual;
- Damage caused by shocks, falls, or floods.

7 DELIVERY CONDITION

The **F205** clamp multimeter is delivered in its packaging box with :

- 2 banana-banana leads, one red and one black
- 2 test probes, one red and one black
- 1 black crocodile clip
- 1 9V batteries
- 1 carrying bag
- the multilingual user manual on mini-CD
- the multilingual getting started guide

