

# Instruction Manual for A6000 Series Universal Digital Panel Meters Units for Measurement of Small DC and AC Currents

### Caution

- (1) Applying a voltage or current exceeding its maximum permissible value may cause the unit to be damaged.
- (2) Always use the unit within the specified voltage range; otherwise, it may cause a fire, electric shock or personal/equipment damage.
- (3) For the purpose of functional improvement, the information written herein may be changed without prior notice.
- (4) Information contained herein is considered accurate to the best of our knowledge. If you have any question or comment on the information, please contact us or our distributor.
- (5) Read this manual carefully and thoroughly before starting to operate the unit, and keep the manual available for future reference.

## 1 Before Using the Unit

Thank you for purchasing our quality designed and manufactured A6000 Series. Before unpacking the unit, check for damages during transportation. If you have noticed any damage, directly contact us or our distributor.

### 1.1 Type Identification

Each model number of the A6000 series has its general specifications, and the following describes each note and the meaning. Before using the unit, check that the model number and specifications of the delivered unit match those of the product you ordered. For optional units, see the separate instruction Manuals.

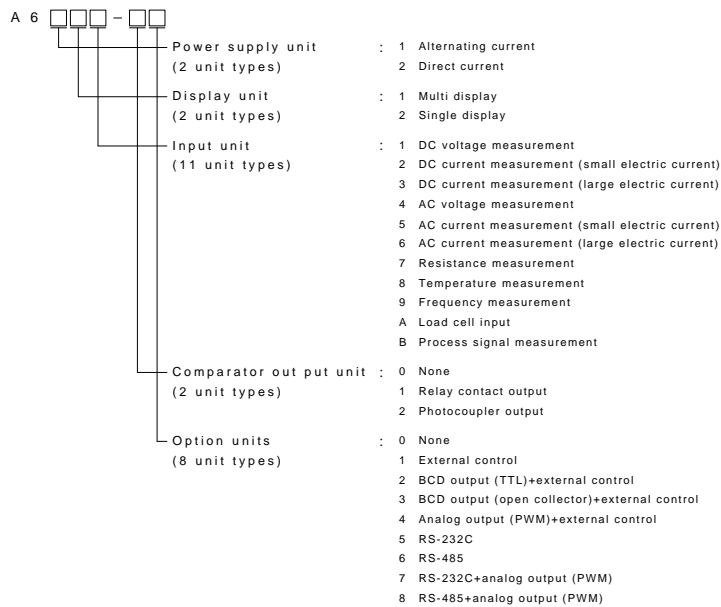

### 1.2 Accessories

Accessory	Quantity	Remarks
6-p terminal cover	2 or 3 each	2 without a comparator output 3 with a comparator output
Mounting band	2 pieces	
Unit indication label	1 each	

## 2 Mounting Method

### 2.1 Panel Cut Size

Cut the panel to mount the A6000 series in accordance with the illustration below:

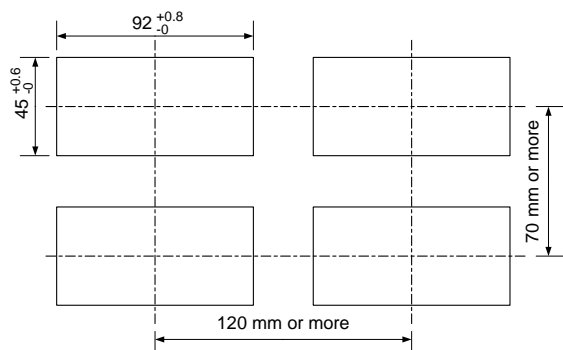

## 2.2 How to Mount the Unit on the Panel

Mount the A6000 series to the panel in accordance with the illustration below:

- (1) Remove the mounting band and insert the case from the front of the panel.
- (2) Fix the case using the mounting band from the rear of the panel.

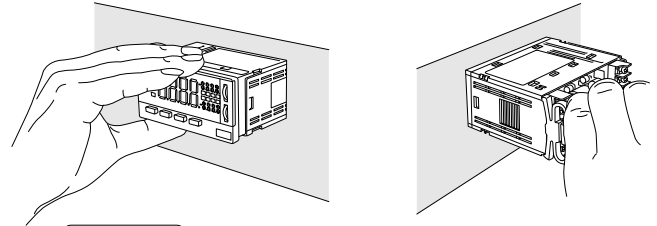

### Caution

- (1) The recommended panel thickness is 0.8 to 5mm.
- (2) Do not install the unit in locations where it is exposed to direct sunlight; where ambient temperature or humidity doesn't meet the requirements below; or where a drastic change in temperature may cause condensation.  
Ambient temperature: 0 to 50°C  
Ambient humidity: 35 to 85%
- (3) Do not install the unit where it is exposed to dust, particles, chemicals harmful to electric components, corrosive gases, etc.
- (4) When this unit is installed inside other equipment, pay attention to the heat radiation and keep the heat inside the equipment 50°C or below.
- (5) Do not install the unit where it is exposed to excessive vibration or shock.
- (6) Install the unit horizontally; otherwise, ventilation will be adversely affected and may result in deterioration.

## 3 Terminals and Connections

Illustration of the rear of the A6000

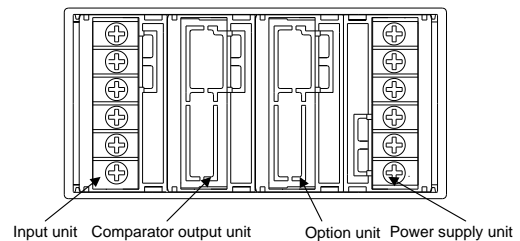

### Caution

Each unit is not replaceable by the customer.

### 3.1 Power supply connections

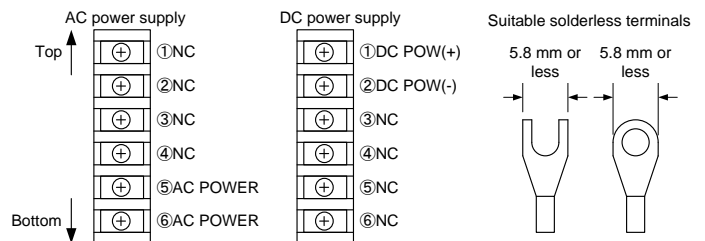

### 3.2 Input Signal Connections

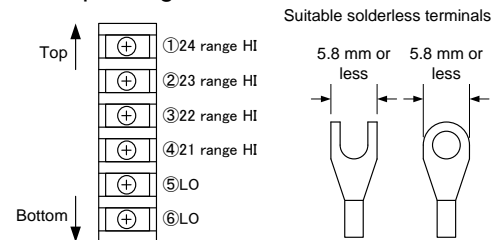

### 3.3 Comparator Output Connections

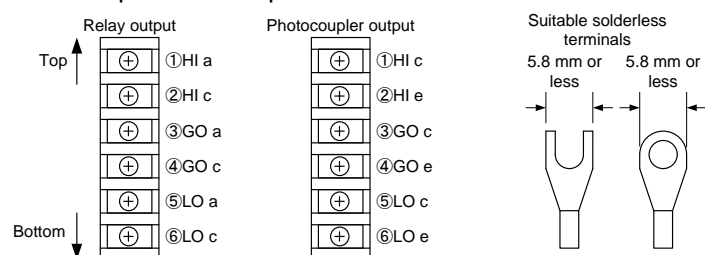

### 3.4 Option connections

For connections of the options, see separate optional function instruction Manuals.

# 4 Parameter Settings

## 4.1 Multi Display Unit

### Names and major functions

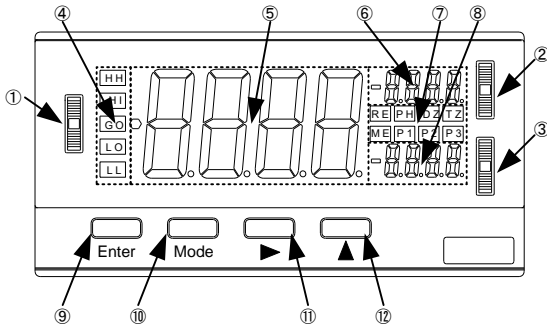

Location	Name	Major function								
①	Jog 1	Menu and value selection at the time of parameter setting; pattern selection when used with Increment.								
②	Jog 2	Changes judgment values when used with the meter relay; sets a current measurement value to a judgment value; switching maximum values, etc. when used without meter relay.								
③	Jog 3	Changes judgment values when used with the meter relay; sets a current measurement value to a judgment value; switching maximum values, etc. when used without meter relay.								
④	Judgment monitor	Displays results of judgment when used with meter relay.								
⑤	Main monitor	Displays a measured value, menu name or a value at the time of parameter setting.								
⑥	Sub monitor 1	Displays a judgment value when used with meter relay; displays a maximum value, etc. when used without meter relay.								
⑦	Function monitor	RE Illuminates when the unit is set to the remote mode via communication function.								
		PH Illuminates when peak hold, valley hold, or peak-valley hold is turned on.								
		DZ Illuminates when Digital Zero is turned on.								
		TZ Illuminates when Tracking Zero is turned on.								
		ME Illuminates when Digital Zero Backup is turned on.								
		P 1	Pattern 1	Pattern 2	Pattern 3	Pattern 4	Pattern 5	Pattern 6	Pattern 7	Pattern 8
		P 2	OFF	OFF	ON	ON	OFF	OFF	ON	OFF
		P 3	OFF	OFF	OFF	OFF	ON	ON	ON	ON
		⑧	Sub monitor 2	Displays a judgment value when used with meter relay; displays a maximum value, etc. when used without meter relay.						
		⑨	Enter	Switches to the parameter setting mode.						
⑩	Mode	Changes modes at the time of parameter setting; switches to the memory mode at the time of normal measurements (when this button is pushed and held.)								
⑪	Shift	Selects digits at the time of parameter setting; DZ control at the time of normal measurements. (when this button is pushed and held.)								
⑫	Increment	Changes values at the time of parameter setting; pattern selection at the time of normal measurements (when this button is pushed and held); special operations								

### Operation procedure diagram

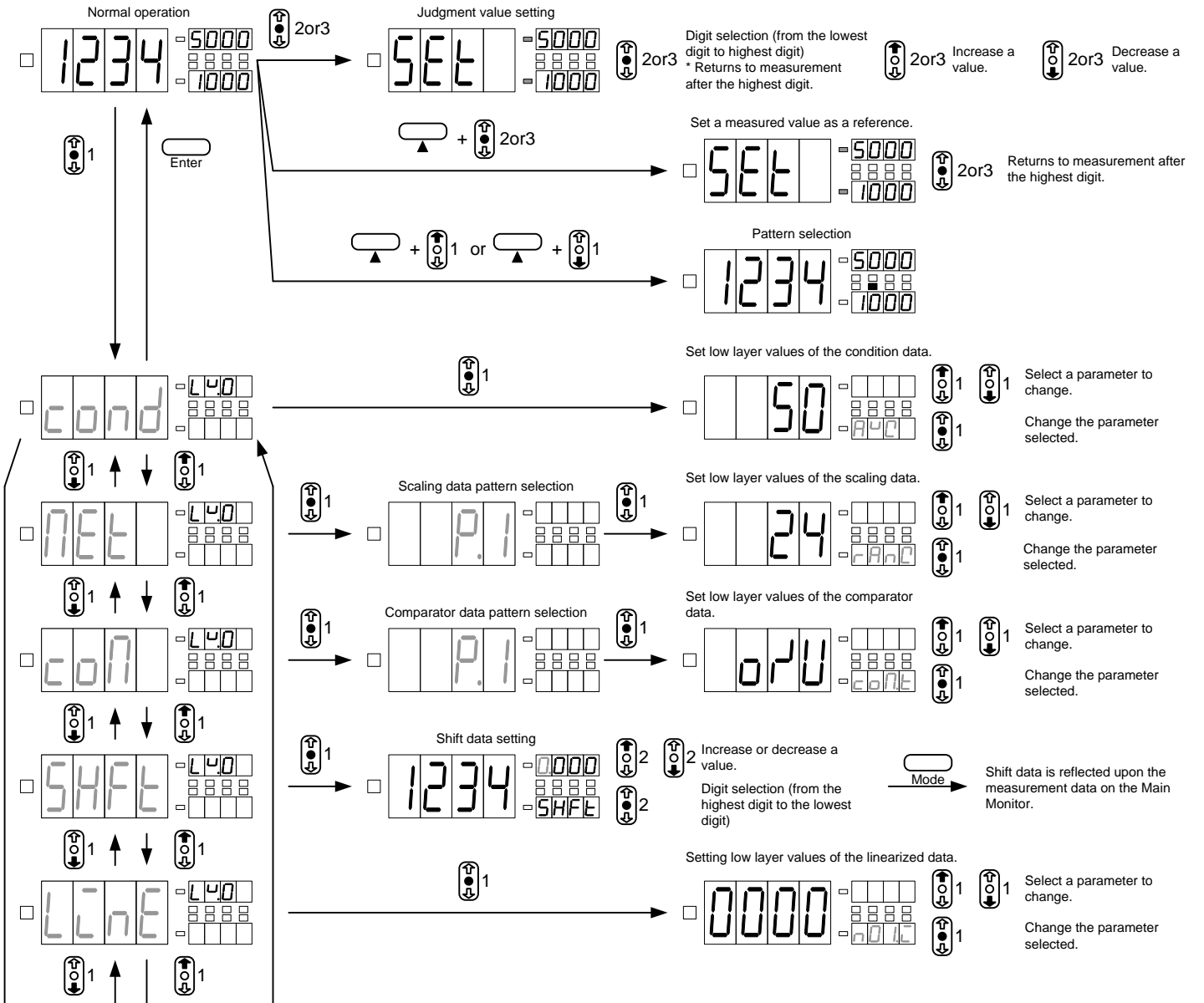

How to set a low layer value (Condition data/scaling data/comparator data)

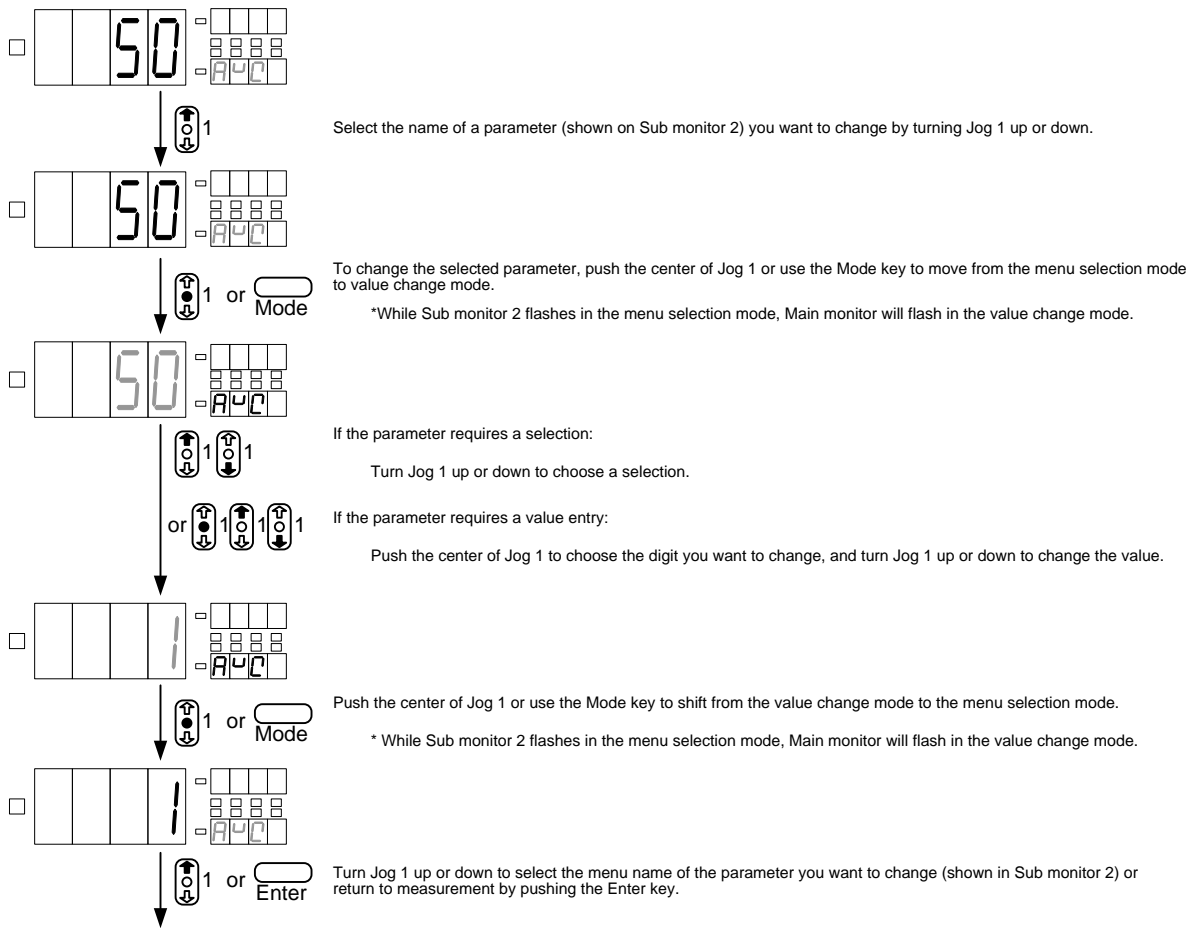

Remarks:

- ※The multi display unit can also follow the operation procedure of the single display unit operation system.
- ※Comparator judgment values can be set not only from Jog 2 and Jog 3 but also from the low layers of the comparator data.
- ※For operation procedures in the memory mode (maximum value/minimum value/(maximum value-minimum value)), see the operation procedure diagram of the single display unit.

4.2 Single Display Unit

Names and major functions

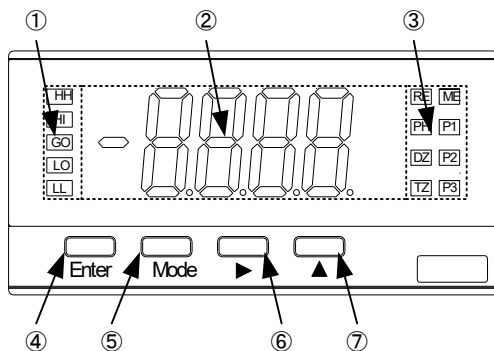

Location	Name	Major function																																						
①	Judgment monitor	Displays judgment results when used with meter relay.																																						
②	Main monitor	Displays a measured value as well as menu names and values at the time of parameter setting.																																						
③	Function monitor	RE Illuminates when the unit is set to the remote mode via communication function.																																						
		PH Illuminates when peak hold, valley hold, or peak-valley hold is turned on.																																						
		DZ Illuminates when Digital Zero is turned on.																																						
		TZ Illuminates when Tracking Zero is turned on.																																						
		ME Illuminates when Digital Zero Backup is turned on.																																						
		<table border="1"> <tr> <td>P 1</td> <td></td> <td>Pattern 1</td> <td>Pattern 2</td> <td>Pattern 3</td> <td>Pattern 4</td> <td>Pattern 5</td> <td>Pattern 6</td> <td>Pattern 7</td> <td>Pattern 8</td> </tr> <tr> <td>P 2</td> <td>P 1</td> <td>ON</td> <td>OFF</td> <td>ON</td> <td>OFF</td> <td>ON</td> <td>OFF</td> <td>ON</td> <td>OFF</td> </tr> <tr> <td>P 3</td> <td>P 2</td> <td>OFF</td> <td>ON</td> <td>OFF</td> <td>OFF</td> <td>ON</td> <td>ON</td> <td>ON</td> <td>ON</td> </tr> <tr> <td></td> <td>P 3</td> <td></td> <td>OFF</td> <td>OFF</td> <td>ON</td> <td>ON</td> <td>ON</td> <td>ON</td> <td>ON</td> </tr> </table>	P 1		Pattern 1	Pattern 2	Pattern 3	Pattern 4	Pattern 5	Pattern 6	Pattern 7	Pattern 8	P 2	P 1	ON	OFF	ON	OFF	ON	OFF	ON	OFF	P 3	P 2	OFF	ON	OFF	OFF	ON	ON	ON	ON		P 3		OFF	OFF	ON	ON	ON
P 1		Pattern 1	Pattern 2	Pattern 3	Pattern 4	Pattern 5	Pattern 6	Pattern 7	Pattern 8																															
P 2	P 1	ON	OFF	ON	OFF	ON	OFF	ON	OFF																															
P 3	P 2	OFF	ON	OFF	OFF	ON	ON	ON	ON																															
	P 3		OFF	OFF	ON	ON	ON	ON	ON																															
④	Enter	Switches to the parameter setting mode.																																						
⑤	Mode	Changes modes at the time of parameter setting; switches to the memory mode at the time of normal measurements (when this button is pushed and held.)																																						
⑥	Shift	Selects digits at the time of parameter setting; DZ control at the time of normal measurements. (when this button is pushed and held.)																																						
⑦	Increment	Changes values at the time of parameter setting; pattern selection at the time of normal measurements (when this button is pushed and held) ; special operations																																						

Operation procedure diagram

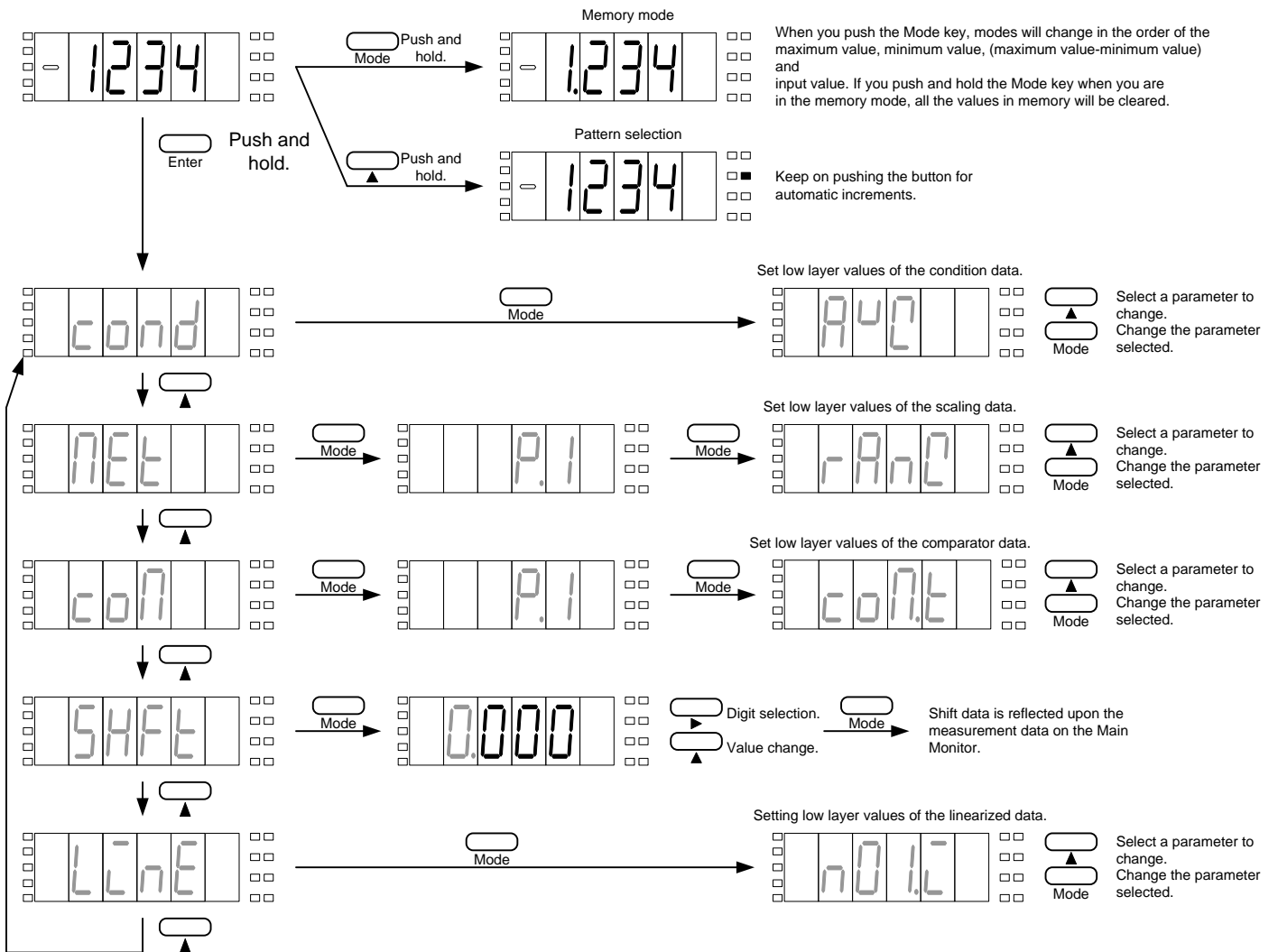

How to set a low layer value (Condition data/scaling data/comparator data)

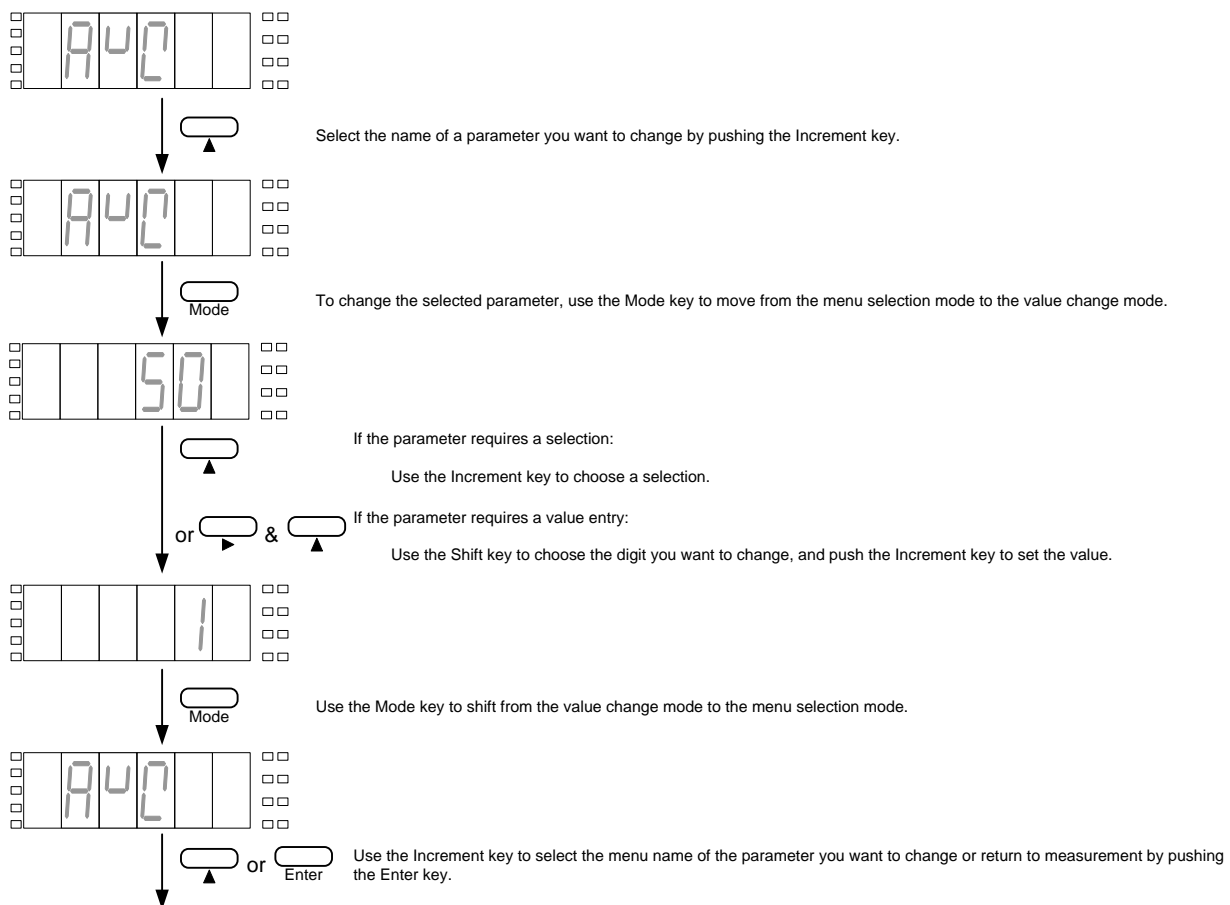

### 4.3 Numeric and Character Indications

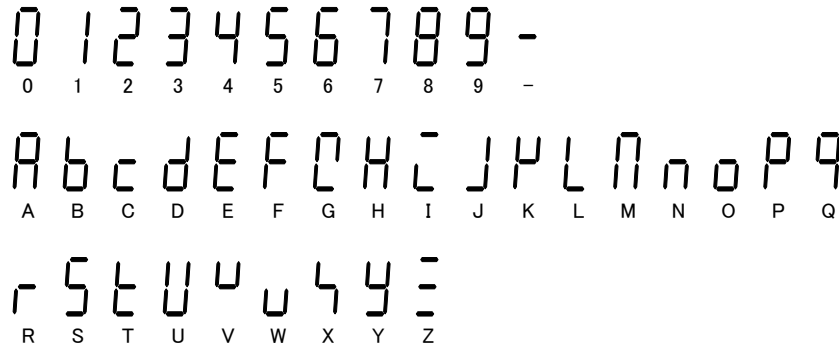

### 4.4 Protection Levels

Each parameter of the A6000 has an individual protection level, and by setting the protection level of the condition data, you can set an access level. (For the protect level of each parameter, see the P.L. column of the tables in Section 4.5.)

The higher the protection level is, the less the number of settable parameters will be. If you set the protection level to the strictest LV3, you can change the protection level only, and all the other parameters may not be changed. (No comparator judgment value can be changed using the jog switches in this case.)

\*The protection level set at the time of shipment is LV1. (Settings of display colors, scaling and judgment-related values only are available.)

### 4.5 List of the Parameters

The parameters for the process signal measurement unit can be roughly divided into three types: condition data which deal with basic functions including sampling time; scaling data which control measurement including input range; and comparator data (for meter relay only) which deal with comparator output.

#### 4.5.1 Condition Data

Menu indication	Parameter name	Initial value	P.L.	Setting range or alternatives	Major setting purpose and remarks
AVG	Average times	50	0	1/2/4/8/10/20/50/100/200/400/800/1000/2000/5000	Selects Conversion rate (average times of internal sampling; sampling time: approx. 1 millisecond) *For the AC measurement unit, the max is 400 times on average (approx. 2.5 times/second).(Initial Value 400)
MAV	Average times of movements	1	0	1/2/4/8/16/32	Selects the average times of movements.Filtering effects: Small<1(OFF)-2-4-8-16-32>Big
S.WD	Step wide	1	0	1/2/5/10	Selects the range of display changes to maintain image display consistency. (If this parameter is set to 5, the lowest digit will display either 0 or 5 only).
CLR	Display color	RED	1	RED/GREEN	Selects display colors.*Only when without meter relay.
CLR.T	Display color type	AUTO	1	AUTO/MANU	Selects automatic (red in the HI or LO mode or green in the GO mode) or manual setting for display color type. *Only when with meter relay.
HI.CL	HI display color	RED	1	RED/GREEN	Selects red or green as display color at the time of HI judgment.*Only when CLR.T is MANU.
GO.CL	GO display color	GREEN	1	RED/GREEN	Selects red or green as display color at the time of GO judgment.*Only when CLR.T is MANU.
LO.CL	LO display color	RED	1	RED/GREEN	Selects red or green as display color at the time of LO judgment.*Only when CLR.T is MANU.
BLNK	Display blank level	OFF	0	OFF/LV1/LV2/LV3/ON	Selects the display brightness. <bright OFF-LV1-LV2-LV3-ON >turned off
J.SW	Jog SW	ON	0	ON/OFF	Selects whether the jog SW is used or not.*With the multi display unit only.
PVH	PH Selection	PH	0	PH/VH/PVH	Selects a type that operates when the PH function is turned on (peak hold/valley hold/peak-valley hold).
DZ.BU	DZ backup	OFF	0	OFF/ON	Selects whether the digital zero value is backed up or not at the time when the unit is turned off.
PS	P.SEL	1	0	1/2/4/8	Selects the number of patterns available for the pattern selection function.
LINE	Linearize	OFF	0	OFF/2/4/8/16	Selects whether the linearize function is enabled/disabled and sets the number of correction points.
TR.T	TZ time	000	0	000 to 999	Selects whether the tracking zero function is enabled/disabled and sets the correction time (setup value/conversion rate).
TR.W	TZ correction range	01	0	01 to 99	Sets the correction range of the tracking zero function.*Only when TR.T is set to a value other than 000.
P.ON	Power on delay time	0	0	0 to 9	Sets the time between the startup and actual start of measurements (setup value x 1 second).
PRO	Protection level	LV.1	3	Lv.0/LV.1/LV.2/LV.3	Selects the protection level to prevent operation mistakes.High< LV3-LV2-LV1-LV0 >Low
U.NO.	Unit number indication	OFF	0	OFF/ON	Selects whether the code of a unit mounted at the time of startup is displayed or not.
S/H.T	Start/hold type	A	0	A/B	Selects an operation type of start/hold (A: free run; B: one shot).*Only with the external control.
S/H.D	S/H delay time	0	0	0 to 9999	Sets the delay time at the time of startup (setup value x 1 ms).*Only with the external control.
PVH.T	PH type	A	0	A/B	Selects an operation type of peak hold (A: real-time display; B: results display).*Only with the external control.
DZ.C	DZ control	SW	0	SW/TERM	Selects a control method of Digital Zero (SW: front key; TERM: external control terminal).*Only with the external control.
PS.C	P.SEL control	SW	0	SW/TERM	Selects a control method of Pattern Selection (SW: front key; TERM: external control terminal).*Only with the external control.
BCD.L	BCD logic	N.LOG	0	N.LOG/P.LOG	Selects the BCD output logic (N: negative logic; P: positive logic).*Only when the BCD output is available.
BAUD	Baud rate	9600	1	2400/4800/9600/19200/38400	Sets a baud rate for communication.*Only when the communication function is available.
DATA	Data length	7	1	7/8	Selects the data length for communication.*Only when the communication function is available.
P.BIT	Parity bit	E	1	E/O/N	Selects the parity bit for communication.*Only when the communication function is available.
STP.B	Stop bit	2	1	1/2	Selects the stop bit for communication.*Only when the communication function is available.
T-	Delimiter	CR.LF	1	CR.LF/CR	Selects a delimiter for communication.*Only when the communication function is available.
ADR	Equipment ID	01	1	01 to 99	Selects the equipment ID for the RS-485 function.*Only when the RS-485 function is available.

### 4.5.2 Scaling Data

Menu indication	Parameter name	Initial value	P.L.	Setting range or alternatives	Major setting purpose and remarks
RANG	Input range	24	1	21/22/23/24	Selects an input range.*Note that input terminals vary depending on the actual input range.
FSC	Full scale indication	9999	2	-9999 to +9999	Sets the relationship between the input signal and its indication. * In the case of AC input, please use it by "+" setting by all means. It is not displayed normally when I use it by "-" setting.
FIN	Full scale input	9999	2	-9999 to +9999	
OFS	Offset indication	0	2	-9999 to +9999	
OIN	Offset input	0	2	-9999 to +9999	
DLHI	Digital limiter HI	9999	0	-9999 to +9999	Sets the upper limit of the displayable range. (Any value equal to or exceeding the digital limiter HI setting will not be updated and kept at the setup value.)
DLLLO	Digital limiter LO	-9999	0	-9999 to +9999	Sets the lower limit of the displayable range. (Any value equal to or below the digital limiter LO setting will not be updated and kept at the setup value.)
A.O.U.T	Analog output type	0-1	1	0-1/0-10/1-5/4-20	Selects an analog output range.*Only when the analog output is available.
A.O.H.I	Analog output HI	9999	1	-9999 to +9999	Sets the relationship between indications and analog outputs.*Only when the analog output is available.
A.O.L.O	Analog output LO	0	1	-9999 to +9999	
DP	Decimal point	None	2	Each digit can be set independently.	Sets the position of the decimal point.

### 4.5.3 Comparator Data (for meter relay only)

Menu indication	Parameter name	Initial value	P.L.	Setting range or alternatives	Major setting purpose and remarks
COM.T	Comparator output type	O/U	1	O/U/ERR	Select either [above or below] or error comparator types.
HI-S	HI judgment value	1000	2	-9999 to +9999	Sets a HI judgment value.*Only when COM.T is O/U.
LO-S	LO judgment value	500	2	-9999 to +9999	Sets a LO judgment value.*Only when COM.T is O/U.
N.VAL	Nominal value	5000	2	-9999 to +9999	Sets a nominal value.*Only when COM.T is ERR.
ERR1	Error 1	5.00	2	0.00 to 99.99	Sets an error.*Only when COM.T is ERR.
HI-H	HI hysteresis	0	1	0 to +999	Sets a HI hysteresis value *Only when COM.T is O/U.
LO-H	LO hysteresis	0	1	0 to +999	Sets a LO hysteresis value *Only when COM.T is O/U.
ER1.H	Error 1 hysteresis	1	1	0 to +999	Sets an error hysteresis *Only when COM.T is ERR.
HI-L	HI logic	N.O	0	N.O/N.C	Sets a HI output logic (N.O.=normally open or N.C.=normally closed)*Output when the power is OFF is always open (OFF).
GO-L	GO logic	N.O	0	N.O/N.C	Sets a GO output logic (N.O.=normally open or N.C.=normally closed)*Output when the power is OFF is always open (OFF).
LO-L	LO logic	N.O	0	N.O/N.C	Sets a LO output logic (N.O.=normally open or N.C.=normally closed)*Output when the power is OFF is always open (OFF).

## 5 Setting Examples

### 5.1 Scaling Data Setting Examples

Example 1

When the voltage range of the input signal is 0 to 1mA, corresponding indication values should be 0 to 5000.

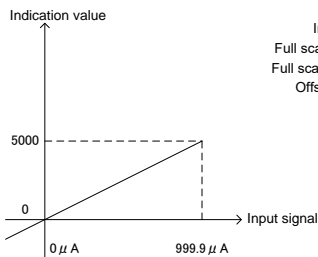

Input range (RANG) : 22  
 Full scale indication (FSC) : 5000  
 Full scale input value (FIN) : 9999  
 Offset indication (OFS) : 0  
 Offset input (OIN) : 0  
 Decimal point (DP) : None (Set to illuminate all the digits.)

Example 3

When the voltage range of the input signal is 4 to 20mA, corresponding indication values should be 0 to 2000.

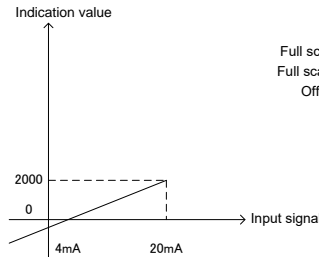

Input range (RANG) : 24  
 Full scale indication (FSC) : 2000  
 Full scale input value (FIN) : 2000  
 Offset indication (OFS) : 0  
 Offset input (OIN) : 400  
 Decimal point (DP) : None (Set to illuminate all the digits.)

□ As the indication range (FSC-OFS=2000) is large than the actual resolution (FIN-OIN=1600), the indication will change in steps of more than one.

Example 2

When the input signal is between 0 to 500μA, indications are changed from 0.0 to 500.0 thereby limiting indication range to between 0 and 5000.

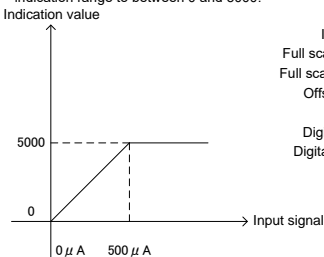

Input range (RANG) : 22  
 Full scale indication (FSC) : 5000  
 Full scale input value (FIN) : 5000  
 Offset indication (OFS) : 0  
 Offset input (OIN) : 0  
 Digital limiter HI (DLHI) : 5000  
 Digital limiter LO (DLLLO) : 0  
 Decimal point (DP) : Illuminates at the Frist lowest digit.

Example 4

When the voltage range of the input signal is 4 to 20mA, corresponding indication values should be 2000 to 0.

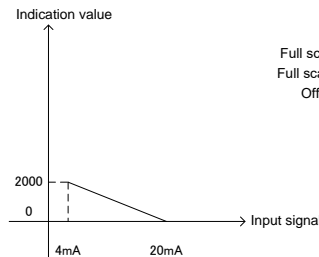

Input range (RANG) : 24  
 Full scale indication (FSC) : 0  
 Full scale input value (FIN) : 2000  
 Offset indication (OFS) : 2000  
 Offset input (OIN) : 0  
 Decimal point (DP) : None (Set to illuminate all the digits.)

□ As the indication range (FSC-OFS=2000) is large than the actual resolution (FIN-OIN=1600), the indication will change in steps of more than one.

5.2 Comparator Data Setting Examples (for meterrelay only)

Example 1

Above and below setup mode

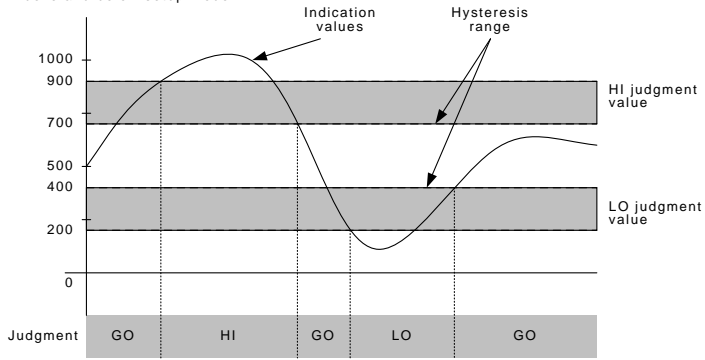

※The hysteresis is effective either in the range lower than the HI judgment value or that higher than the LO judgment value.

Example 2

Error judgment mode

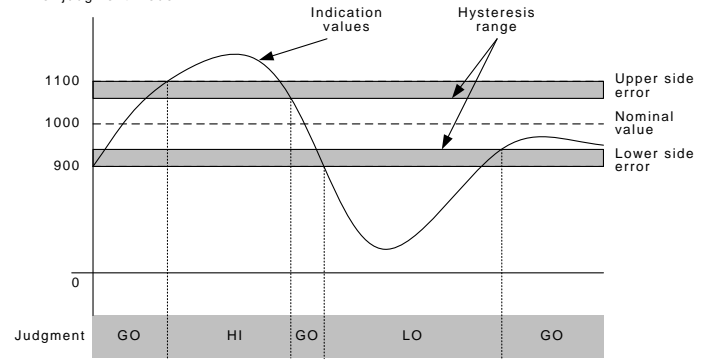

※Error is to be set as a percentage of the nominal value.  
 ※The hysteresis is to be set as xx digits of the indication value.  
 ※The hysteresis is effective either in the range lower than the upper side error or that higher than the lower side error.

## 6 Specifications and Measurements

### 6.1 Input Specifications

●DC current measurements (Small electric current)

Range	Measurement range	Indication	Error (23°C ±5°C; 35 to 85%)	Input impedance	Maximum permissible input
21	±99.99 μA	Offset: ±9999 Full scale: ±9999	±(0.1% of rdg + 2digit)	Approx. 1kΩ	±10mA
22	±999.9 μA			Approx. 100Ω	
23	±9.999mA			Approx. 10Ω	
24	±99.99mA			Approx. 1Ω	

Sampling rate : Maximum approx. 1,000 times/second

\* The error is applied when the sampling rate is 20 times/second or less.

●AC current measurements (Small electric current)

Range	Measurement range	Indication	Error (23°C ±5°C; 35 to 85%)	Input impedance	Maximum permissible input
21	99.99 μA	Offset: ±9999 Full scale: ±9999	±(0.5% of rdg + 20digit)	Approx. 1kΩ	10mA
22	999.9 μA			Approx. 100Ω	
23	9.999mA			Approx. 10Ω	
24	99.99mA			Approx. 1Ω	

Sampling rate : Maximum approx. 2.5 times/second

Measurement method : True rms value calculation

Frequency range : 50Hz or 60Hz (21,22range), 40Hz to 1kHz (23,24range)

Response speed : Approx. 1 second (10% to 90%)

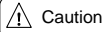

Caution

Less than 0.5% of an FSC set point are dead zone, and, as for the AC measurement unit, indication always becomes 0.

### 6.2 General Specifications

Display	: Multi display Main display: Red/green 7-segment display (character height: approx. 20 mm) Sub display: Red 7-segment display (character height: approx. 6 mm) Single display Red/green 7-segment display (character height: approx. 20 mm)
Display range	: -9999 to 9999
Operational temperature	: 0 to 50°C 35 to 85%RH
Storage temperature	: -10 to 70 °C; 60%RH or less
Power supply	: AC PS AC 100 to 240V ±10% DC PS DC 12 to 48V ±10%
Power consumption	: AC PS Maximum load: Approx. 8 VA at 100 VAC DC PS Maximum load: Approx. 7 W at 24 VDC
External dimension	: 48 mm (H) x 96 mm (W) x 97.5 mm (with no DX option unit mounted)
Weight	: Approx. 450g
Withstand voltage	: AC PS PS-input, output: 1,500 VAC, 1 minute (AC PS) Input-output: 500 VDC, 1 minute Output-output: 500 VDC, 1 minute Case-PS, input, output: 1,500 VAC, 1 minute DC PS PS-input, output: 500 VDC, 1 minute (DC PS) Input-output: 500 VDC, 1 minute Output-output: 500 VDC, 1 minute Case-PS, input, output: 1,500 VAC, 1 minute
Insulation resistance	: AC PS Among the above terminals: 500 VDC 100 MΩ or more DC PS Among the above terminals: 500 VDC 100M Ω or more

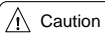

Caution

The PS voltage must be applied or shut down at once (not gradually).  
Take at least a 10-second interval between a shutdown and startup.

### 6.3 Output for Comparison Specifications(for meter relay only)

●Common specifications

Conditions for comparison	Judgment result
Indicated value □ Upper limit judgment value	HI
Lower limit judgment value □ Indicated value □ Upper limit judgment value	GO
Lower limit judgment value □ Indicated value	LO

Judgment value setup range : -9999 to +9999

Hysteresis : Can be set in the range of 1 to 999 digits for each judgment value

Operating speed : Depends on the sampling rate

●Relay contact output

Contact quantity : Relay contact × 3

Contact rating : 250V AC 2A, 30V DC 2A

●Photo coupler output

Output quantity : Photo coupler × 3

Output rating : 30V DC 20mA

### 6.4 External Dimensions

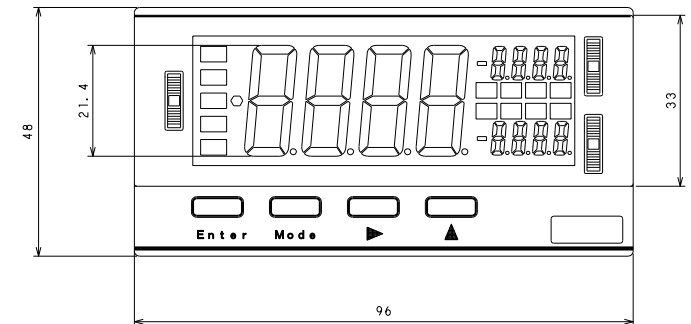
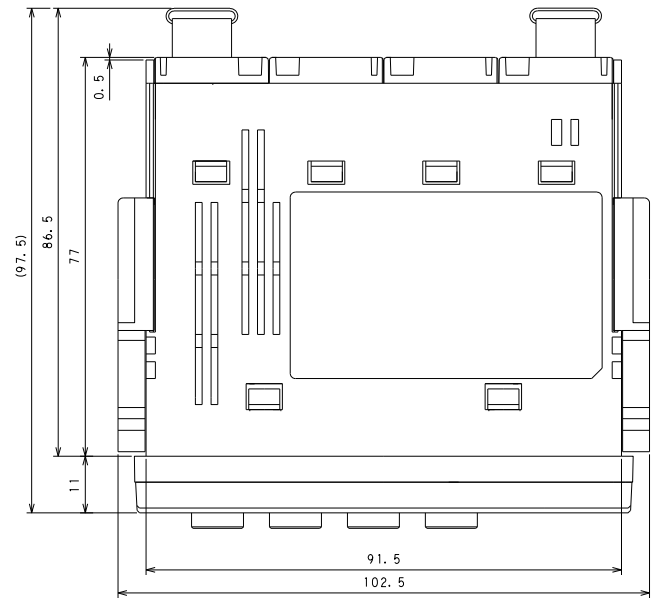

## 7 Warranty and Service

### 7.1 Warranty

The manufacturer warrants to the original retail customer its A6000 series universal digital panel meter to be free of defects in material and workmanship for use under normal care and will repair or replace any meter at no charge to the customer during the one (1) year warranty period of the meter.

### 7.2 After Sales Service

Under strict quality control measures, this product was manufactured, tested, inspected and shipped. Should a defect in manufacture or workmanship be identified, please return the product to our distributor or directly to us. It would be highly appreciated if you could give a detailed account of the fault and enclose it with the product.



**WATANABE ELECTRIC INDUSTRY CO., LTD.**

6-16-19, Jingumae, Shibuya-ku, Tokyo 150-0001, Japan  
Phone: (81)3-3400-6141  
Homepage <http://www.watanabe-electric.co.jp/en/>



# Instruction Manual for A6000 Series Universal Digital Panel Meters

## External Control Unit

### 1 Before Using the Unit

This instruction manual is for the external control unit of the A6000 series. Read this manual along with the main unit's instruction manual before using the unit.

A6000's rear panel

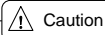
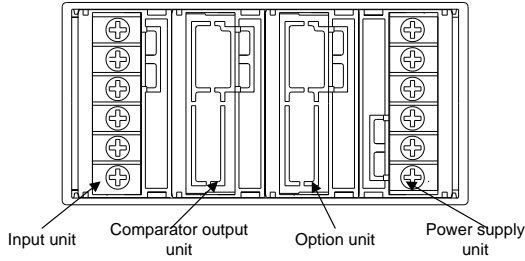

None of the units are replaceable by the customer.

### 2 Terminals and Connections

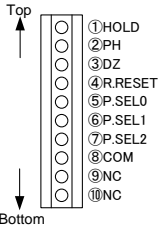

Terminal	Function																																				
S/H	*Start/hold control terminal. The "hold" state is turned on when this terminal is at the same potential as the COM terminal or short-circuited.																																				
PH	*Peak hold control terminal. The peak hold function is turned on when this terminal is at the same potential as the COM terminal or short-circuited.																																				
DZ	*Digital zero control terminal. The digital zero function is turned on when this terminal is at the same potential as the COM terminal or short-circuited. This setting is valid only when the external control terminal is selected as the control method for digital zero using condition data.																																				
R.RESET	*Relay reset control terminal. The relay reset function is turned on (only for the meter relay) when this terminal is at the same potential as the COM terminal or short-circuited.																																				
P.SEL0 P.SEL1 P.SEL2	*"Pattern selection" control terminals. Patterns can be selected by setting these terminals at the same potential as the COM terminal or short-circuiting them as shown in the table below. These settings are valid only when the external control terminal is selected as the control method for pattern selection using condition data.																																				
	<table border="1" style="width: 100%; text-align: center;"> <thead> <tr> <th></th> <th>Pattern 1</th> <th>Pattern 2</th> <th>Pattern 3</th> <th>Pattern 4</th> <th>Pattern 5</th> <th>Pattern 6</th> <th>Pattern 7</th> <th>Pattern 8</th> </tr> </thead> <tbody> <tr> <td>P.SEL0</td> <td>Open</td> <td>Short-circuited</td> <td>Open</td> <td>Short-circuited</td> <td>Open</td> <td>Short-circuited</td> <td>Open</td> <td>Short-circuited</td> </tr> <tr> <td>P.SEL1</td> <td>Open</td> <td>Open</td> <td>Short-circuited</td> <td>Open</td> <td>Open</td> <td>Short-circuited</td> <td>Short-circuited</td> <td>Open</td> </tr> <tr> <td>P.SEL2</td> <td>Open</td> <td>Open</td> <td>Open</td> <td>Open</td> <td>Short-circuited</td> <td>Short-circuited</td> <td>Short-circuited</td> <td>Short-circuited</td> </tr> </tbody> </table>		Pattern 1	Pattern 2	Pattern 3	Pattern 4	Pattern 5	Pattern 6	Pattern 7	Pattern 8	P.SEL0	Open	Short-circuited	Open	Short-circuited	Open	Short-circuited	Open	Short-circuited	P.SEL1	Open	Open	Short-circuited	Open	Open	Short-circuited	Short-circuited	Open	P.SEL2	Open	Open	Open	Open	Short-circuited	Short-circuited	Short-circuited	Short-circuited
	Pattern 1	Pattern 2	Pattern 3	Pattern 4	Pattern 5	Pattern 6	Pattern 7	Pattern 8																													
P.SEL0	Open	Short-circuited	Open	Short-circuited	Open	Short-circuited	Open	Short-circuited																													
P.SEL1	Open	Open	Short-circuited	Open	Open	Short-circuited	Short-circuited	Open																													
P.SEL2	Open	Open	Open	Open	Short-circuited	Short-circuited	Short-circuited	Short-circuited																													
COM	External control's common terminals, which are at the same potential as the LO or AG terminal for the input circuit.																																				

### 3 Timing Charts

Start/hold type A

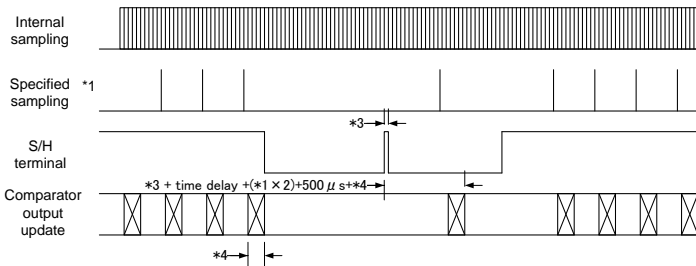

Start/hold type B

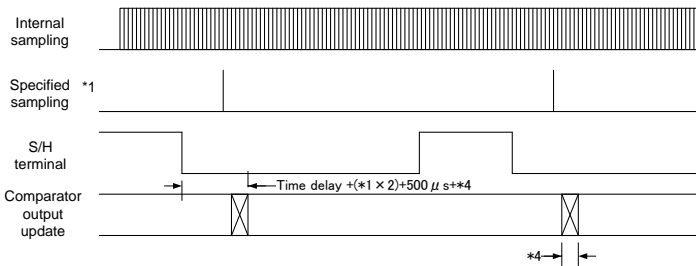

\*1 Specified sampling

The sampling speed is determined by the AVG parameter setting of condition data as shown in the table below:

AVG setting	Sampling speed	Sampling cycle	AVG setting	Sampling speed	Sampling cycle
1	1041.65 times/sec	Approx. 960 μs	100	10.4165 times/sec	Approx. 96 ms
2	520.825 times/sec	Approx. 1.92 ms	200	5.20825 times/sec	Approx. 192 ms
4	260.4125 times/sec	Approx. 3.84 ms	400	2.604125 times/sec	Approx. 384 ms
8	130.20625 times/sec	Approx. 7.68 ms	800	1.3020625 times/sec	Approx. 768 ms
10	104.165 times/sec	Approx. 9.6 ms	1000	1.04165 times/sec	Approx. 960 ms
20	52.0825 times/sec	Approx. 19.2 ms	2000	0.520825 times/sec	Approx. 1.92 sec
50	20.833 times/sec	Approx. 48 ms	5000	0.20833 times/sec	Approx. 4.8 sec

※Using a temperature measuring unit, the sampling speed is half of the value in the table above when the RTD is selected and quarter of it when the TC is selected.

※It is different, and a frequency measurement unit is indication update time with a range.

Please refer to input specifications (Clause 6.1) of an instruction manual for frequency measurement.

\*3 External start signal

The width of the external start signal must be from between 500 μs to a specified sampling cycle. A time delay can be set for the external start using the S/H delay time parameter of the condition data.

\*4 Time delay for comparator output

Relay output: 10 ms max., photocoupler output: 200 μs max.

### 4 Specifications and External Dimensions

●External control terminal

Internal circuit: Pulled up to approximately +5 V (through a 10 kΩ resistor).

Control signal's HI level: 4.2 to 5 V relative to the COM terminal

Control signal's LO level: 0 to 0.4 V relative to the COM terminal

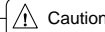

The external control circuit's COM terminals and the input circuit's LO or AG terminal are set at the same DC potential.

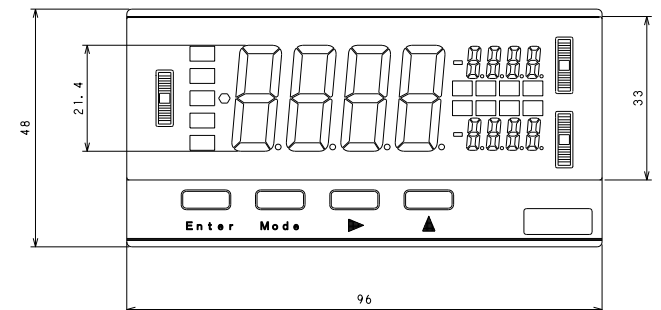
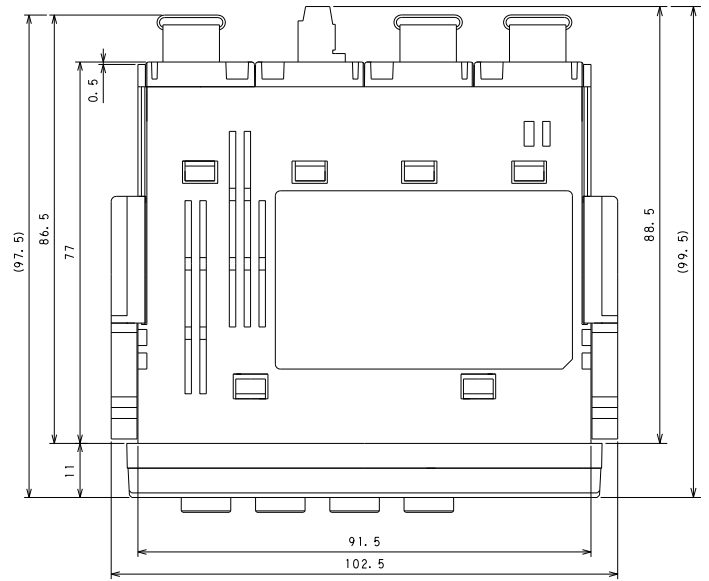

## 5 Warranty and Service

### 5.1 Warranty

The manufacturer grants a warranty to the original retail customer stating that its A6000 series universal digital panel meter is free of defects in material and workmanship for use under normal care, and will repair or replace the meter at no charge to the customer during the one (1) year warranty period.

### 5.2 After Sales Service

This product was manufactured, tested, inspected and shipped under strict quality control measures. Should a defect in manufacture or workmanship be identified, please return the product to our distributor or directly to us. It would be highly appreciated if you could give a detailed account of the problem and enclose it with the product.

*watanabe*

WATANABE ELECTRIC INDUSTRY CO., LTD.

6-16-19, Jingumae, Shibuya-ku, Tokyo 150-0001, Japan  
Phone: (81)3-3400-6141

Homepage <http://www.watanabe-electric.co.jp/en/>

# Instruction Manual for A6000 Series Universal Digital Panel Meters BCD Output and External Control Unit

## 1 Before Using the Unit

This instruction manual is for the BCD output and external control unit of the A6000 series. Read this manual along with the main unit's instruction manual before using the unit.

A6000's rear panel

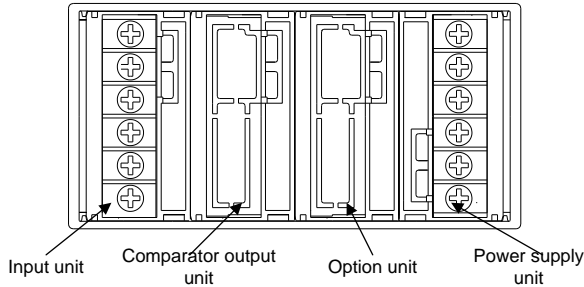

**Caution**

None of the units are replaceable by the customer.

## 2 Terminals and Connections

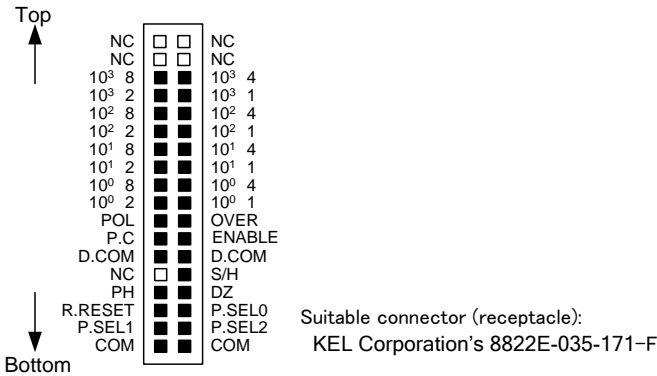

Terminal	Function
10 <sup>0</sup> 1	Least significant bit output of least significant BCD digit. The output logic can be switched using condition data.
10 <sup>0</sup> 2	Second least significant bit output of least significant BCD digit. The output logic can be switched using condition data.
10 <sup>0</sup> 4	Second most significant bit output of least significant BCD digit. The output logic can be switched using condition data.
10 <sup>0</sup> 8	Most significant bit output of least significant BCD digit. The output logic can be switched using condition data.
⋮	⋮
10 <sup>3</sup> 1	Least significant bit output of most significant BCD digit. The output logic can be switched using condition data.
10 <sup>3</sup> 2	Second least significant bit output of most significant BCD digit. The output logic can be switched using condition data.
10 <sup>3</sup> 4	Second most significant bit output of most significant BCD digit. The output logic can be switched using condition data.
10 <sup>3</sup> 8	Most significant bit output of most significant BCD digit. The output logic can be switched using condition data.
POL	BCD polarity output. The output logic can be switched using condition data.
OVER	BCD overflow output. The output logic can be switched using condition data.
P.C	BCD print instruction output.
ENABLE	"Enable BCD" control terminal. The BCD output is set to the high-impedance state or the transistor is turned off when this terminal is short-circuited or at the same potential as the D.COM terminal.
D.COM	BCD output's common terminals
S/H	"Start/hold" control terminal. The "hold" state is turned on when this terminal is at the same potential as the COM terminal or short-circuited.
PH	"Peak hold" control terminal. The peak hold function is turned on when this terminal is at the same potential as the COM terminal or short-circuited.
DZ	"Digital zero" control terminal. The digital zero function is turned on when this terminal is at the same potential as the COM terminal or short-circuited. This setting is valid only when the external control terminal is selected as the control method for digital zero using condition data.
R.RESET	"Relay reset control terminal. The relay reset function is turned on (only for the meter relay) when this terminal is at the same potential as the COM terminal or short-circuited.
P.SEL0 P.SEL1 P.SEL2	"Pattern selection" control terminals. Patterns can be selected by setting these terminals at the same potential as the COM terminal or short-circuiting them as shown in the table below. These settings are valid only when the external control terminal is selected as the control method for pattern selection using condition data.
COM	External control's common terminals, which are at the same potential as the LO or AG terminal for the input circuit.

## 3 Timing Charts

Start/hold type A

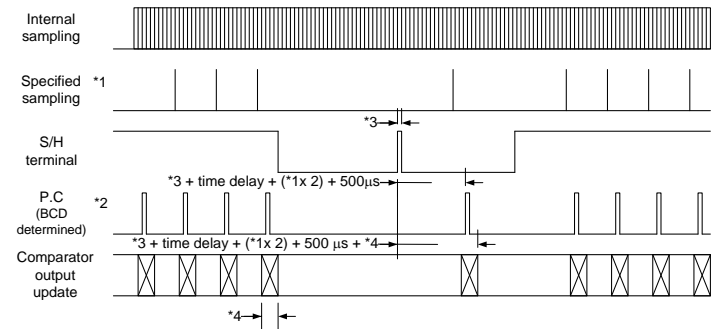

Start/hold type B

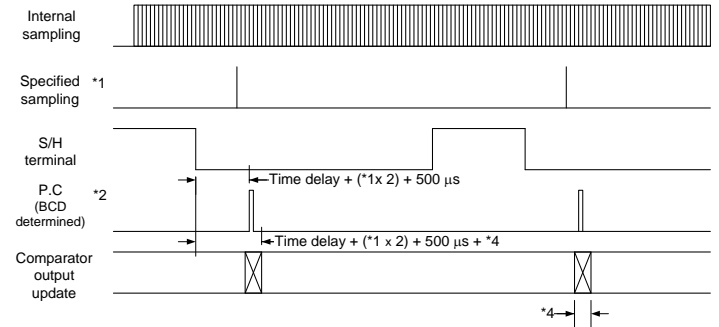

\*1 Specified sampling

The sampling speed is determined by the AVG parameter setting of condition data as shown in the table below:

AVG setting	Sampling speed	Sampling cycle	AVG setting	Sampling speed	Sampling cycle
1	1041.65 times/sec	Approx. 960 μs	100	10.4165 times/sec	Approx. 96 ms
2	520.825 times/sec	Approx. 1.92 ms	200	5.20825 times/sec	Approx. 192 ms
4	260.4125 times/sec	Approx. 3.84 ms	400	2.604125 times/sec	Approx. 384 ms
8	130.20625 times/sec	Approx. 7.68 ms	800	1.3020625 times/sec	Approx. 768 ms
10	104.165 times/sec	Approx. 9.6 ms	1000	1.04165 times/sec	Approx. 960 ms
20	52.0825 times/sec	Approx. 19.2 ms	2000	0.520825 times/sec	Approx. 1.92 sec
50	20.833 times/sec	Approx. 48 ms	5000	0.20833 times/sec	Approx. 4.8 sec

※Using a temperature measuring unit, the sampling speed is half of the value in the table above when the RTD is selected and quarter of it when the TC is selected.  
 ※It is different, and a frequency measurement unit is indication update time with a range.  
 Please refer to input specifications (Clause 6.1) of an instruction manual for frequency measurement.

\*2 P.C output signal width

The output signal width is determined by the specified sampling setting as shown in the table below:

AVG setting	P.C output width	AVG setting	P.C output width
1	Approx. 220 μs	100	Approx. 30 ms
2	Approx. 0.25 ms	200	
4	Approx. 1.15 ms	400	
8	Approx. 2.3 ms	800	
10	Approx. 2.9 ms	1000	
20	Approx. 5.8 ms	2000	
50	Approx. 14.4 ms	5000	

※The output width is always 30 ms for the frequency measurement unit.

\*3 External start signal

The width of the external start signal must be from between 500 μs to a specified sampling cycle. A time delay can be set for the external start using the S/H delay time parameter of the condition data.

\*4 Time delay for comparator output

Relay output: 10 ms max., photocoupler output: 200 μs max.

## 4 Specifications and External Dimensions

### •BCD output

Output type : open collector or TTL-compatible

Polarity : The applicable transistor (open collector) or polarity bit (TTL) turns on when negative values are indicated.

Overflow : The applicable transistor (open collector) or bit (TTL) turns on when the overflow state is indicated.

Output logic : Can be switched alternatively (the logic for the P.C bit cannot be changed).

Output rating : 30 V DC and 10 mA (open collector), or fan-out 2 (TTL)

**Caution**

The BCD output logic can be switched using the BCD logic parameter (BCD.L) of the condition data, which is positive when BCD.L is set to P.LOG and negative when BCD.L is set to N.LOG for an output type of Open collector. This logic is reversed if the output type is "TTL."

### •External control terminal

Internal circuit: Pulled up to approximately +5 V (through a 10 kΩ resistor).

Control signal's HI level: 4.2 to 5 V relative to the COM terminal

Control signal's LO level: 0 to 0.4 V relative to the COM terminal

**Caution**

- 1) The BCD output circuit and the external control circuit are electrically isolated from each other (withstand voltage: 500 V DC for one minute).
- 2) The external control circuit's COM terminals and the input circuit's LO or AG terminal are set at the same DC potential.

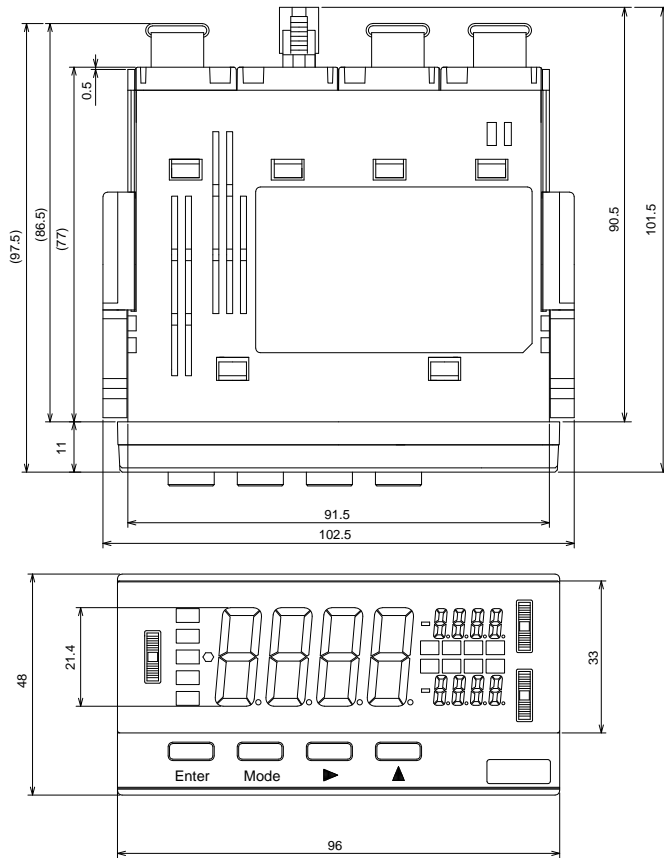

**5 Warranty and Service**

**5.1 Warranty**

The manufacturer grants a warranty to the original retail customer stating that its A6000 series universal digital panel meter is free of defects in material and workmanship for use under normal care, and will repair or replace the meter at no charge to the customer during the one (1) year warranty period.

**5.2 After Sales Service**

This product was manufactured, tested, inspected and shipped under strict quality control measures. Should a defect in manufacture or workmanship be identified, please return the product to our distributor or directly to us. It would be highly appreciated if you could give a detailed account of the problem and enclose it with the product.

**watanabe**  
**WATANABE ELECTRIC INDUSTRY CO., LTD.**

6-16-19, Jingumae, Shibuya-ku, Tokyo 150-0001, Japan  
 Phone: (81)3-3400-6141  
 Homepage <http://www.watanabe-electric.co.jp/en/>

# Instruction Manual for A6000 Series Universal Digital Panel Meters Analog Output and External Control Unit

## 1 Before Using the Unit

This instruction manual is for the analog output and external control unit of the A6000 series. Read this manual along with the main unit's instruction manual before using the unit.

## 2 Terminals and Connections

A6000's rear panel

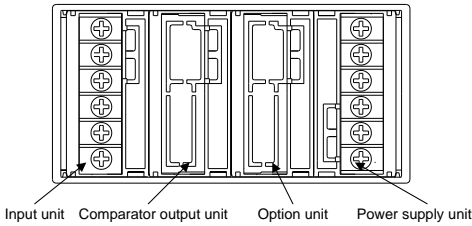

**Caution**

None of the units are replaceable by the customer.

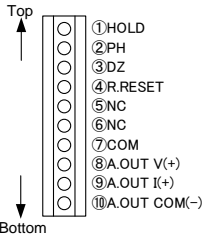

Terminal	Function
S/H	"Start/hold" control terminal. The "hold" state is turned on when this terminal is at the same potential as the COM terminal or short-circuited.
PH	"Peak hold" control terminal. The peak hold function is turned on when this terminal is at the same potential as the COM terminal or short-circuited.
DZ	"Digital zero" control terminal. The digital zero function is turned on when this terminal is at the same potential as the COM terminal or short-circuited. This setting is valid only when the external control terminal is selected as the control method for digital zero using condition data.
R.RESET	"Relay reset" control terminal. The relay reset function is turned on (only for the meter relay) when this terminal is at the same potential as the COM terminal or short-circuited.
COM	External control's common terminals, which are at the same potential as the LO or AG terminal for the input circuit.
A.OUT V(+)	Voltage output terminal of analog output.
A.OUT I(+)	Current output terminal of analog output.
A.OUT COM(-)	Common terminal of analog output. Insulated from input LO or AG terminal/external control COM terminal.

## 3 Timing Charts

Start/hold type A

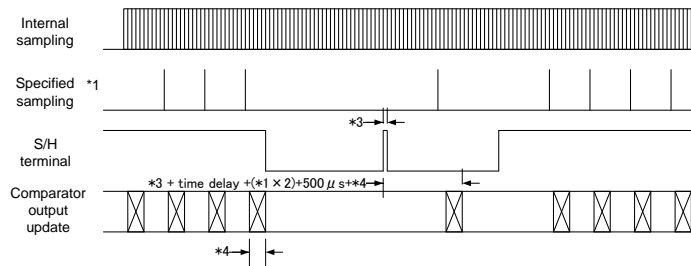

Start/hold type B

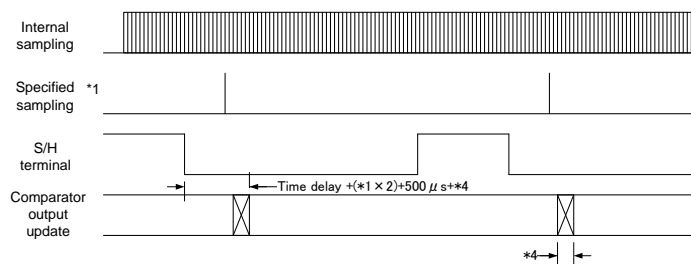

\*1 Specified sampling

The sampling speed is determined by the AVG parameter setting of condition data as shown in the table below:

AVG setting	Sampling speed	Sampling cycle	AVG setting	Sampling speed	Sampling cycle
1	1041.65 times/sec	Approx. 960 μs	100	10.4165 times/sec	Approx. 96 ms
2	520.825 times/sec	Approx. 1.92 ms	200	5.20825 times/sec	Approx. 192 ms
4	260.4125 times/sec	Approx. 3.84 ms	400	2.604125 times/sec	Approx. 384 ms
8	130.20625 times/sec	Approx. 7.68 ms	800	1.3020625 times/sec	Approx. 768 ms
10	104.165 times/sec	Approx. 9.6 ms	1000	1.04165 times/sec	Approx. 960 ms
20	52.0825 times/sec	Approx. 19.2 ms	2000	0.520825 times/sec	Approx. 1.92 sec
50	20.833 times/sec	Approx. 48 ms	5000	0.20833 times/sec	Approx. 4.8 sec

※Using a temperature measuring unit, the sampling speed is half of the value in the table above when the RTD is selected and quarter of it when the TC is selected.

※It is different, and a frequency measurement unit is indication update time with a range. Please refer to input specifications (Clause 6.1) of an instruction manual for frequency measurement.

\*3 External start signal

The width of the external start signal must be from between 500 μs to a specified sampling cycle. A time delay can be set for the external start using the S/H delay time parameter of the condition data.

\*4 Time delay for alarm output

Relay output: 10 ms max., photocoupler output: 200 μs max.

## 4 Specifications and External Dimensions

●Analog output (PWM)

Output type	Load resistance	Accuracy	Response speed	Ripple
0 to 1V	10kΩ or more	±(0.5% of FS)	Approx. 0.5 second	50mVp-p
0 to 10V				
1 to 5V				
4 to 20mA	550Ω or less			25mVp-p

Conversion system : PWM conversion

Resolution : Equivalent to 14 bits

Scaling : Digital scaling

●External control terminal

Internal circuit : Pulled up to approximately +5V (through a 10kΩ resistor).

Control signal's HI level : 4.2 to 5V relative to the COM terminal

Control signal's LO level : 0 to 0.4V relative to the COM terminal

**Caution**

- Analog output circuits and external control circuits are insulated (withstand voltage 500V DC, one minute)
- COM terminals of external control circuits and LO terminals of input circuits have the same electric potential at direct current.

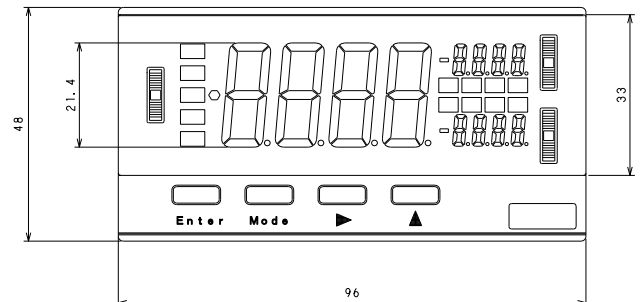
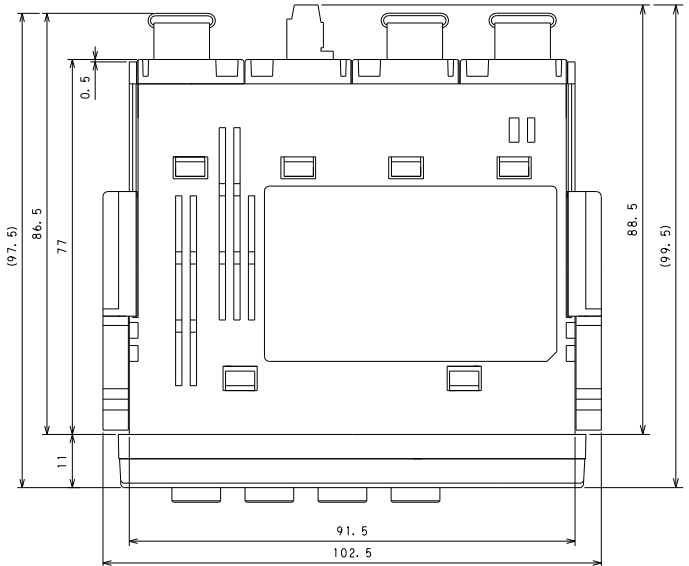

## 5 Warranty and Service

### 5.1 Warranty

The manufacturer grants a warranty to the original retail customer stating that its A6000 series universal digital panel meter is free of defects in material and workmanship for use under normal care, and will repair or replace the meter at no charge to the customer during the one (1) year warranty period.

### 5.2 After Sales Service

This product was manufactured, tested, inspected and shipped under strict quality control measures. Should a defect in manufacture or workmanship be identified, please return the product to our distributor or directly to us. It would be highly appreciated if you could give a detailed account of the problem and enclose it with the product.

*watanabe*

WATANABE ELECTRIC INDUSTRY CO., LTD.

6-16-19, Jingumae, Shibuya-ku, Tokyo 150-0001, Japan  
Phone: (81)3-3400-6141

Homepage <http://www.watanabe-electric.co.jp/en/>

# Instruction Manual for A6000 Series Universal Digital Panel Meter

~RS-232C/RS-485 and Analog Output Units~

## 1 Before Using the Unit

This Operation Manual corresponds to the communication function + analog output optional units of the A6000 Series Universal Digital Panel Meters. When using the instrument, please read through this manual in combination with the Operation Manual of the main unit.

## 2 Terminals and Connections

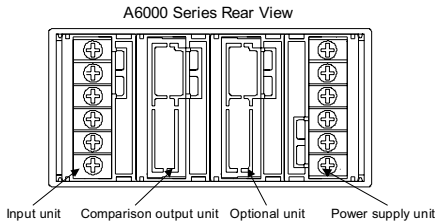

### CAUTION

The A6000 series does not support replacement of each unit by the customer.

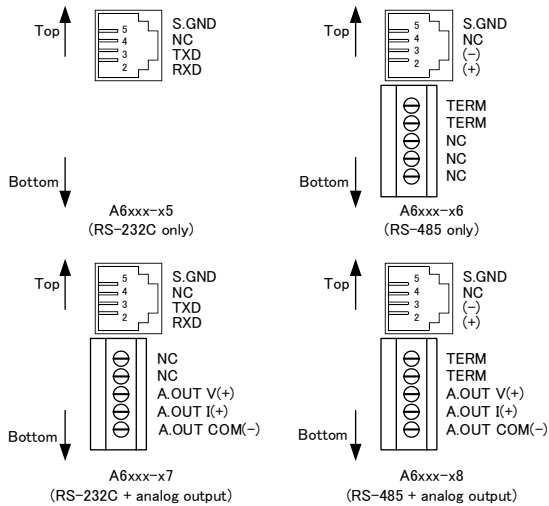

\* Modular jack : RJ-14(6P4C)

## 3 Examples of Connections and Use

### 3.1 Connecting the RS-232C Interface

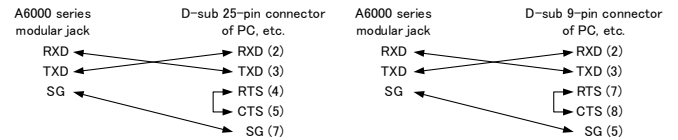

### 3.2 Connecting the RS-485 Interface

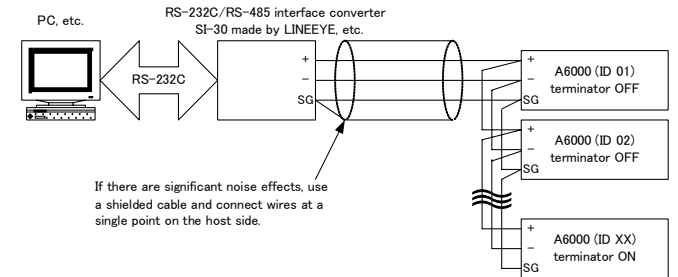

\*If cascade wiring is carried out with a RS-485 connection, use a commercially available Y-type split connector or the like.  
 \*To turn ON an RS-485 I/O unit's terminator (200 Ω), short-circuit the two TERM terminals.

### 3.3 Control Codes Used in RS-485 Interface

Code	Hexadecimal	Name
STX	02H	Start of Text
ETX	03H	End of Text
EOT	04H	End of Transmission
ENQ	05H	Enquiry
ACK	06H	Acknowledge

### 3.4 Establishing RS-485 Communication

Function	1	2	3	4	5	6	7	Char. Length	1	2	3	4	5	6	7	8	9	10	Char. Length
Establishing communication	ENQ	0	1	CR	LF			3	ACK	0	1	CR	LF						3
	*Device ID is specified in 2 digits (00 is invalid).								(Normal response) * Response time: 40 ms maximum  (No response is made if the device ID is different.)										
Canceling communication	EOT	CR	LF					1	(No response is made to cancellation of communication.) * Response time: 20 ms maximum										
	*If another device ID is specified without canceling communication, communication is still possible.																		

## 3.5 RS-485 Communication formats

As a means of error detection, a block check character (BCC) checksum is added to the RS-485 communication function of the A6000. See the following illustrations for details on the transmission and reception formats. (RS-232C communication format is same as the command table which is mentioned in the next section.)

#### Example of BCC Checksum for Transmission

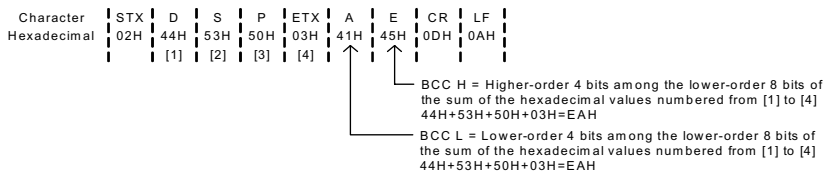

#### Example of BCC Checksum for Reception

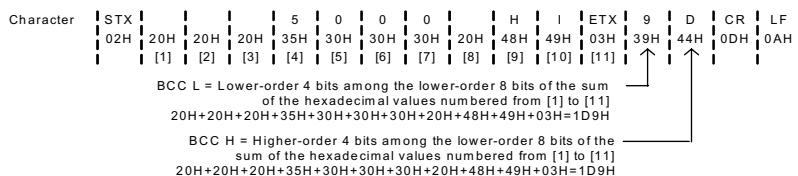









Function	1	2	3	4	5	6	7	8	9	10	11	12	13	14	15	Char. Length	1	2	3	4	5	6	7	8	9	10	11	12	13	14	15	16	17	18	Char. Length		
Step wide response	S	W	D	CR	LF											3	1	CR	LF															1	(Response of a state in which step wide is "1")		
																		1	0	CR	LF														2	(Response of a state in which step wide is "10")	
Step wide setting	S	W	D	1	CR	LF										5	Y	E	S			CR	LF											5	(Sets step wide to "1.")		
	S	W	D	1	0	CR	LF									6	Y	E	S			CR	LF											5	(Sets step wide to "10.")		
																	* Step wide is switched immediately after setting.																				
Display color response	C	L	R	CR	LF											3	R	E	D	CR	LF														3	(Response of a state in which the display color is red)	
																		R	E	E	N	CR	LF												5	(Response of a state in which the display color is green)	
																		N	O	?	CR	LF												5	(Response made if the comparison output unit is not installed)		
Display color setting	C	L	R	R	CR	LF										5	Y	E	S			CR	LF												5	(Sets display color to red.)	
	C	L	R	G	CR	LF										5	Y	E	S			CR	LF												5	(Sets display color to green.)	
																	* Step wide is switched immediately after setting.																				
Display color type response	C	L	T	CR	LF											5	A	U	T	O	CR	LF													4	(Response of a state in which the display color type is Auto)	
																		M	A	N	U	A	L	CR	LF										6	(Response of a state in which the display color type is Manual)	
																		N	O	?	CR	LF													5	(Response made if the comparison output unit is not installed)	
Display color type setting	C	L	T	A	CR	LF										5	Y	E	S			CR	LF												5	(Sets the display color type to Auto.)	
	C	L	T	M	CR	LF										5	Y	E	S			CR	LF												5	(Sets the display color type to Manual.)	
																	* The display color type is switched immediately after setting.																				
																	* Response made if the comparison output unit is not installed.																				
HI display color response	C	H	I	CR	LF											3	R	E	D	CR	LF															3	(Response of a state in which the HI display color is red)
																		G	R	E	E	N	CR	LF											5	(Response of a state in which the HI display color is green)	
																		A	U	T	O	CR	LF													4	(Response of a state in which the display color type is Auto)
																		N	O	?	CR	LF													5	(Response made if the comparison output unit is not installed)	
HI display color setting	C	H	I	R	CR	LF										5	Y	E	S			CR	LF												5	(Sets HI display color to red.)	
	C	H	I	G	CR	LF										5	Y	E	S			CR	LF												5	(Sets HI display color to green.)	
																	* HI display color is switched immediately after setting.																				
																	* Response made if the comparison output unit is not installed.																				
																	* Response of the state of independent judgment specifications.																				
GO display color response	C	G	O	CR	LF											3	R	E	D	CR	LF															3	(Response of a state in which the GO display color is red)
																		G	R	E	E	N	CR	LF											5	(Response of a state in which the GO display color is green)	
																		A	U	T	O	CR	LF												4	(Response of a state in which the display color type is Auto)	
																		N	O	?	CR	LF													5	(Response made if the comparison output unit is not installed)	
GO display color setting	C	G	O	R	CR	LF										5	Y	E	S			CR	LF												5	(Sets GO display color to red.)	
	C	G	O	G	CR	LF										5	Y	E	S			CR	LF												5	(Sets GO display color to green.)	
																	* GO display color is switched immediately after setting.																				
																	* Response made if the comparison output unit is not installed.																				
																	* Response of the state of independent judgment specifications.																				
LO display color response	C	L	O	CR	LF											3	R	E	D	CR	LF															3	(Response of a state in which the LO display color is red)
																		G	R	E	E	N	CR	LF											5	(Response of a state in which the LO display color is green)	
																		A	U	T	O	CR	LF												4	(Response of a state in which the display color type is Auto)	
																		N	O	?	CR	LF													5	(Response made if the comparison output unit is not installed)	
LO display color setting	C	L	O	R	CR	LF										5	Y	E	S			CR	LF												5	(Sets LO display color to red.)	
	C	L	O	G	CR	LF										5	Y	E	S			CR	LF												5	(Sets LO display color to green.)	
																	* LO display color is switched immediately after setting.																				
																	* Response made if the comparison output unit is not installed.																				
																	* Response of the state of independent judgment specifications.																				

Function	1	2	3	4	5	6	7	8	9	10	11	12	13	14	15	Char. Length	1	2	3	4	5	6	7	8	9	10	11	12	13	14	15	16	17	18	Char. Length	
Display blank response	B	L	K	CR	LF											3	O	F	F	CR	LF														3	
																																			3	
																																			3	
																																			3	
																																			2	
Display blank setting	B	L	K	O	F	F	CR	LF								7	Y	E	S			CR	LF												5	
	B	L	K	L	V	1	CR	LF								7	Y	E	S			CR	LF												5	
	B	L	K	L	V	2	CR	LF								7	Y	E	S			CR	LF													5
	B	L	K	L	V	3	CR	LF								7	Y	E	S			CR	LF													5
	B	L	K	O	N	CR	LF									6	Y	E	S			CR	LF												5	
Jog switch response	J	S	W	CR	LF											3	O	N	CR	LF															2	
																																			3	
																																			5	
Jog switch setting	J	S	W	O	N	CR	LF									6	Y	E	S			CR	LF												5	
	J	S	W	O	F	F	CR	LF								7	Y	E	S			CR	LF												5	
																																			5	
Digital zero backup response	B	D	Z	CR	LF											3	O	N	CR	LF																2
																																				3
Digital zero backup control	B	D	Z	O	N	CR	LF									6	Y	E	S			CR	LF													5
	B	D	Z	O	F	F	CR	LF								7	Y	E	S			CR	LF													5
Digital zero data save command	S	A	V	CR	LF											3	Y	E	S			CR	LF													5
																																			5	
Response of the number of patterns for pattern select	P	S	N	CR	LF											3	1	CR	LF																1	
																																			1	
Control over the number of patterns for pattern select	P	S	N	1	CR	LF										5	Y	E	S			CR	LF												5	
	P	S	N	8	CR	LF										5	Y	E	S			CR	LF												5	
Linearize function status response	L	I	N	CR	LF											3	O	F	F	CR	LF														3	
																																			1	
																																			2	
Linearize function status setting	L	I	N	O	F	F	CR	LF								7	Y	E	S			CR	LF												5	
	L	I	N	2	CR	LF										5	Y	E	S			CR	LF												5	
	L	I	N	1	6	CR	LF									6	Y	E	S			CR	LF												5	
Tracking zero response	T	R	K	CR	LF											3	O	N	T	=	1	W	=	1	CR	LF									10	
																																			12	
																																			3	
Tracking zero setting	T	R	K	T	=	1	CR	LF								7	Y	E	S			CR	LF												5	
	T	R	K	T	=	9	9	CR	LF							8	Y	E	S			CR	LF												5	
	T	R	K	W	=	1	CR	LF								7	Y	E	S			CR	LF												5	
	T	R	K	W	=	9	9	CR	LF							8	Y	E	S			CR	LF												5	
	T	R	K	T	=	0	CR	LF								7	Y	E	S			CR	LF												5	

\* In order to validate a tracking zero setup, please perform a number of times setup of an average continuously after carrying out a tracking zero setup.





Function	1	2	3	4	5	6	7	8	9	10	11	12	13	14	15	Char. Length	
Condition data parameter response	A	L	1	CR	LF											3	
	A V G 1 CR LF																5
	(Response of a state in which the number of averaging times is "1")																
	M A V O F F CR LF																7
	(Response of a state in which the moving averaging function is OFF)																
	S W D 1 CR LF																5
	(Response of a state in which step wide is "1")																
	C L R R E D CR LF																7
	(Response of a state in which the display color is red)																
	C L T M A N U A L CR LF																10
	(Response of a state in which the display color type is Manual)																
	C H H R E D CR LF																7
	(Response of a state in which the HH display color is red)																
	C H I R E D CR LF																7
	(Response of a state in which the HI display color is red)																
	C G O R E D CR LF																7
	(Response of a state in which the GO display color is red)																
	C L O R E D CR LF																7
	(Response of a state in which the LO display color is red)																
	C L L R E D CR LF																7
	(Response of a state in which the LL display color is red)																
	B L K O F F CR LF																7
	(Response of a state in which display blank is OFF)																
	J S W O N CR LF																6
	(Response of a state in which the jog switch is ON)																
	P V H P H - O F F CR LF																10
	(Response of a state in which peak hold select is OFF at PH)																
	B D Z O N CR LF																6
	(Response of a state in which digital zero backup is ON)																
	P S N 1 CR LF																5
	(Response of a state in which pattern select is "1")																
	L I N O F F CR LF																7
	(Response of a state in which linearize is OFF)																
T R K O F F CR LF																7	
(Response of a state in which tracking zero is OFF)																	
P O N 0 CR LF																5	
(Response of a state in which the delay time is "0")																	
P R O L V 0 CR LF																7	
(Response of a state in which the protect level is at LV0)																	
U N O O F F CR LF																7	
(Response of a state in which unit number indication is OFF)																	
S T T A CR LF																5	
(Response of a state in which the start hold type is A)																	
S T D φ CR LF																9	
P V T A CR LF																5	
(Response of a state in which the peak hold type is A)																	
B A U 9 6 0 0 CR LF																8	
(Response of a state in which the baud rate is 9600 bps)																	
D A T 7 CR LF																5	
(Response of a state in which the data length is 7 bits)																	
P B T E V E N CR LF																8	
(Response of a state in which a parity bit is even parity)																	
S B T 2 CR LF																5	
(Response of a state in which a stop bit is 2 bits)																	
D L M C R + L F CR LF																9	
(Response of a state in which a delimiter is CR + LF)																	
A D R 1 CR LF																5	
(Response of a state in which the device ID is 01)																	
Scaling data parameter response	A	L	2	CR	LF											3	
	P . 1 CR LF																3
	(The pattern used previously is responded.)																
	R A N G 2 A CR LF																7
	(Response of a state in which the measurement range is 2 A)																
	I S E L O . C CR LF																8
	(Response of a state in which the input type is open collector)																
	F S C 9 9 9 9 CR LF																10
	(Response of a state in which the full-scale indicated value is "9999")																
	F I N 9 9 9 9 CR LF																10
	(Response of a state in which the full-scale input value is "9999")																
	O F S 0 CR LF																10
	(Response of a state in which the offset indicated value is "0")																
	O I N 0 CR LF																10
	(Response of a state in which the offset input value is "0")																
	P S 1 . 0 0 CR LF																7
	(Response of a state in which the pre-scale value is "1.00")																
	P P R 1 CR LF																5
	(Response of a state in which the frequency division value is "1")																
	D L H I 9 9 9 9 CR LF																10
(Response of a state in which the digital limiter HI value is "9999")																	
D L L O - 9 9 9 9 CR LF																10	
(Response of a state in which the digital limiter LO value is "-9999")																	
A O U T 0 - 1 CR LF																8	
(Response of a state in which the analog output type is 0 to 1 V)																	
A O H I 9 9 9 9 CR LF																9	
(Response of a state in which the analog output HI indicated value is "9999")																	
A O L O 0 CR LF																6	
(Response of a state in which the analog output LO indicated value is "0")																	
U N I T C CR LF																6	
(Response of a state in which the temperature indication unit is °C)																	
D E P O F F CR LF																7	
(Response of a state in which there is no decimal point)																	





Function	1	2	3	4	5	6	7	8	9	10	11	12	13	14	15	Char. Length	1	2	3	4	5	6	7	8	9	10	11	12	13	14	15	16	17	18	Char. Length	
Scaling data setting	M	E	T	CR	LF											3	P	-	1	CR	LF														3	
	* Indication becomes "MET" at the instant the MET command has been received.																(The pattern used previously is responded.)																			
	2	CR	LF														1	P	-	2	CR	LF														3
	(Sets data-setting pattern to "2.")																																			
	M	CR	LF														2	R	A	N	G		2	A	CR	LF									7	
	(Sets the measurement range to 1V.)																																			
	1	V	CR	LF													2	R	A	N	G		1	V	CR	LF									7	
	(Sets the full-scale indicated value to "8000.")																																			
	8	0	0	0	CR	LF											4	F	S	C		9	9	9	9	CR	LF								8	
	(Sets the offset indicated value to "20.")																																			
2	0	CR	LF													1	O	F	S		0	CR	LF												5	
(Sets the offset indicated value to "20.")																																				
E	CR	LF														1	Y	E	S			CR	LF												5	
* Setting necessary data and then sending the E command causes data acquired up to that point to be return to measurement operation.																N O ? CR LF (Response made if a value out of the setting range is input)																				
Comparator data setting *Case of the companson output type is high-and low-limit setting. Sets data-setting pattern to "2" and HI logic to "8000",set LO logic to "-5000", and sets HI &LO logic to normally closed.	C	O	M	CR	LF											3	P	-	1	CR	LF														3	
	* The main unit's indication becomes "COM" at the instant the COM command has been received.																(The pattern used previously is responded.)																			
	2	CR	LF														1	P	-	2	CR	LF														3
	(Sets data-setting pattern to "2.")																																			
	M	CR	LF														1	C	O	M	T		O	/	U	CR	LF									8
	(Sets HI logic to "8000.")																																			
	8	0	0	0	CR	LF											4	H	I	-	S		1	0	0	0	CR	LF								9
	(Sets LO logic to "-5000.")																																			
	-	5	0	0	0	CR	LF										5	L	O	-	S		5	0	0	0	CR	LF							10	
	(Sets HI &LO logic to normally closed.)																																			
	0	CR	LF														1	H	I	-	H		0	CR	LF											6
	(Sets HI logic to normally closed.)																																			
	0	CR	LF														1	L	O	-	H		0	CR	LF											6
	(Sets LO logic to normally closed.)																																			
	N	C	CR	LF													1	H	I	-	L		N	O	CR	LF										
(Sets HI logic to normally closed.)																																				
M	CR	LF														2	H	I	-	L		N	C	CR	LF											7
(Sets LO logic to normally closed.)																																				
N	C	CR	LF													1	G	O	-	L		N	O	CR	LF											7
(Sets HI logic to normally closed.)																																				
E	CR	LF														1	L	O	-	L		N	O	CR	LF											7
(Sets LO logic to normally closed.)																																				
E	CR	LF														1	Y	E	S			CR	LF													5
* A return to measurement operation using the E command (If the N command is sent, a return to side judgment value is made.)																E R R O R 0 CR LF (Response made if a value not meeting the setting conditions is input) N O ? CR LF (Response of a state in which the relevant input unit is not installed)																				
*Case of the compason output type is sets the nominal value to "8000", sets the tolerance 1 to "20.00".	C	O	M	CR	LF											3	P	-	1	CR	LF														3	
	* The main unit's indication becomes "COM" at the instant the COM command has been received.																(The pattern used previously is responded.)																			
	M	CR	LF														1	C	O	M	T		O	/	U	CR	LF									8
	(Sets the comparator output type to tolerance judgment.)																																			
	E	R	R	CR	LF												6	C	O	M	T		E	R	R	CR	LF									8
	(Sets the nominal value to "8000.")																																			
	8	0	0	0	CR	LF											1	N	V	A	L		5	0	0	0	CR	LF								10
	(Sets tolerance 1 to "20.00.")																																			
	2	0	0	0	CR	LF											5	E	R	R	1		2	0	.	0	0	CR	LF							11
	(Sets tolerance 1 to "20.00.")																																			
E	CR	LF														1	E	R	1	H		0	CR	LF											10	
* A return to measurement operation using the E command (If the N command is sent, a return to side judgment value is made.)																E R R O R 0 CR LF (Response made if a value not meeting the setting conditions is input) N O ? CR LF (Response of a state in which the relevant input unit is not installed)																				

\* The same setting methods as those above are also used for setting of other data (such as linearize data).

## 5 Specifications and Dimensions

- RS-232C
  - Baud rate : 38400, 19200, 9600, 4800, or 2400 bps
  - Start bit : 1 bit
  - Data length : 7 bits or 8 bits
  - Parity : even, odd, or none
  - Stop bit : 1 bit or 2 bits
  - Character code : ASCII code
  - Delimiter : CR or CR+LF
- RS-485
  - Baud rate : 38400, 19200, 9600, 4800, or 2400 bps
  - Start bit : 1 bit
  - Data length : 7 bits or 8 bits
  - Parity : even, odd, or none
  - Stop bit : 1 bit or 2 bits
  - Character code : ASCII code
  - Delimiter : CR or CR+LF
  - Error detection : BCC checksum
  - Number of instruments to be connected : 31

●Analog Output (PWM)

Output	Load Resistance	Accuracy	Response Rate	Ripple
0 to 1V	10kΩ or more	±(0.5% of FS)	About 0.5 sec	50mVp-p
0 to 10V				
1 to 5V				
4 to 20mA	550Ω or less			25mVp-p

Conversion method : PWM conversion system  
 Resolution : about 14 bits or equivalent  
 Scaling : digital scheduling

## 6 Warranty and After-sales Services

### 6.1 Warranty

The warranty period of this product is one year from the date of delivery. If a problem occurs during this warranty period and its cause is determined to be attributable to us, and will repair the product without charge.

### 6.2 After-sales Services

This product has been manufactured, tested, and inspected under strict quality control before shipment from the factory. If the product breaks down, contact your sales representative or our local office (or send it). In this case, write down the problem in detail and report it to your service representative (or enclose it with the product).

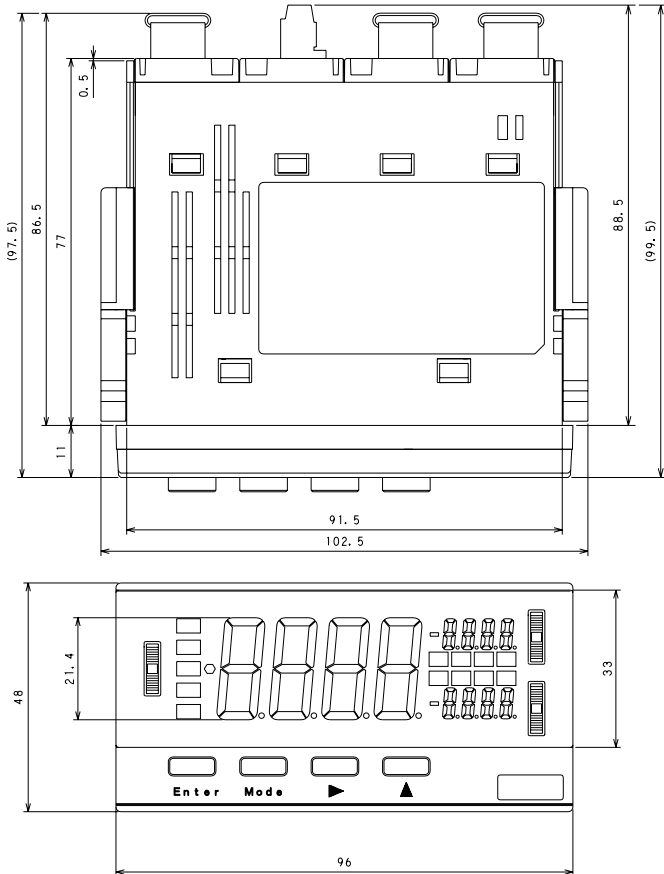

**watanabe**  
 WATANABE ELECTRIC INDUSTRY CO., LTD.

6-16-19, Jingumae, Shibuya-ku, Tokyo 150-0001, Japan  
 Phone: (81)3-3400-6141  
 Homepage <http://www.watanabe-electric.co.jp/en/>