



# EM330 Installation and use instructions

Three-phase energy analyzer for indirect connection (5A) with Modbus, pulse or M-Bus interface

Code 8021422

## General warnings



**HAZARD:** Live parts. Heart attack, burns and other injuries. Disconnect the power supply and load before installing the analyzer. Protect terminals with covers.

The energy analyzer should only be installed by qualified/authorized personnel.



These instructions are an integral part of the product. They should be consulted for all situations tied to installation and use. They should be kept within easy reach of operators, in a clean place and in good conditions.

## Description

The analyzer measures active and reactive energy, summing (*easy connection* mode on) or separating imported energy from exported energy. It manages two energy tariffs using a digital input or Modbus command. It can be equipped with an optional output to communicate measurements: pulse output, RS485 Modbus port or M-Bus port. It measures two DIN modules, with backlit LCD display with sensitive touch screen areas for page scrolling and parameters setting.

## Code key (analyzer side)

EM330-DIN	AVx	3	a	a1	X
Model	<b>AV5:</b> 400 V ac (mains voltage), 5 (6) A, connection via TA <b>AV6:</b> 208–230 V ac (mains voltage), 5(6) A, connection via TA	3 or 4-wire three-phase current system; two-phase current system, 3-wire	<b>H:</b> auxiliary power 90–260 V ac/dc <b>L:</b> auxiliary power 12–60 V ac/dc	Output type: <b>O1:</b> pulse <b>S1:</b> Modbus RS485 port <b>M1:</b> M-Bus port	No option included

## Product (Fig. 1)

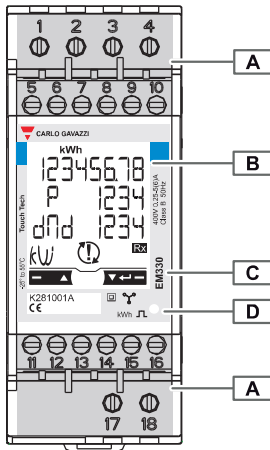

Fig. 1

Area	Description
A	Current and communication connection terminals
B	Backlit LCD display with sensitive touch screen areas
C	Model, feature summary and serial number
D	LED: <ul style="list-style-type: none"> <li>blinking red: pulse weight proportionate to the TA and TV ratio result, see <b>"Technical Specifications"</b> on page 14</li> <li>orange on: total active power negative. Control only run if the imported and exported energies are measured separately (<b>Measure = b</b>).</li> </ul>

## Display (Fig. 2)

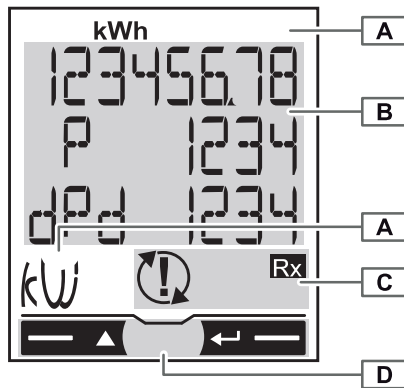





Fig. 2

Area	Description
A	Unit of measure area
B	Specific section information area
C	Signal area: <ul style="list-style-type: none"> <li>: incorrect voltage connections</li> <li>: incorrect current connections</li> <li>: version S1 only. Modbus command correctly received.</li> <li>: version S1 only. Modbus command correctly sent to master.</li> </ul>
D	Command area

# Connection diagrams

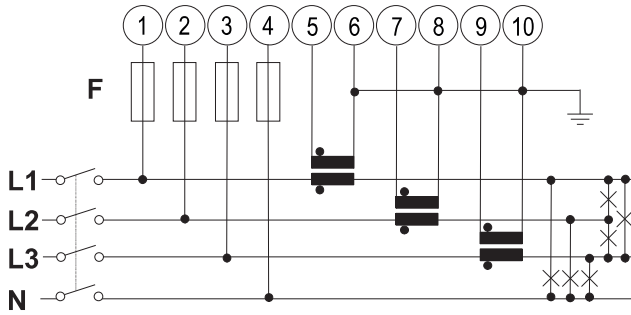

Fig. 3

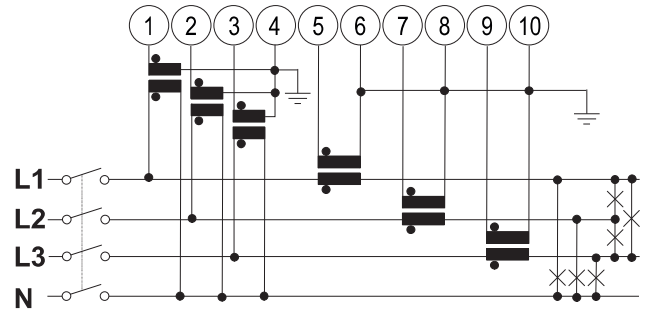

Fig. 4

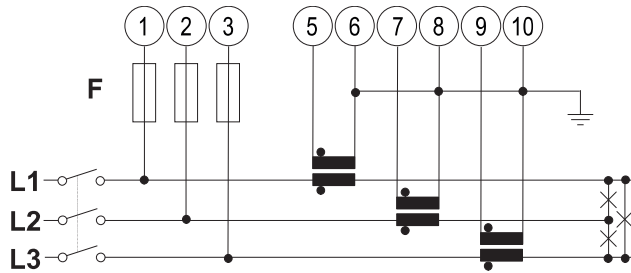

Fig. 5

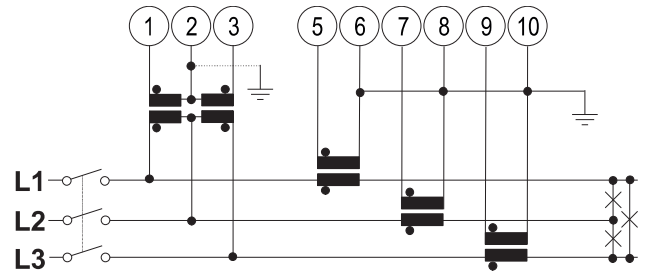

Fig. 6

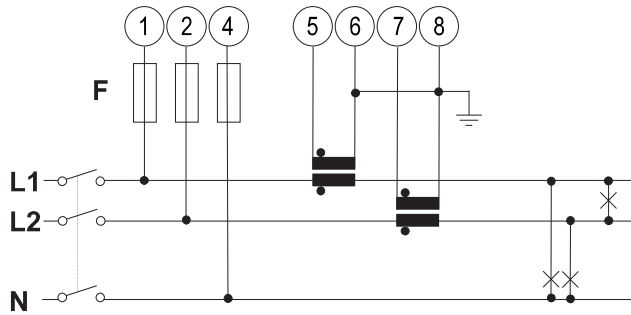

Fig. 7

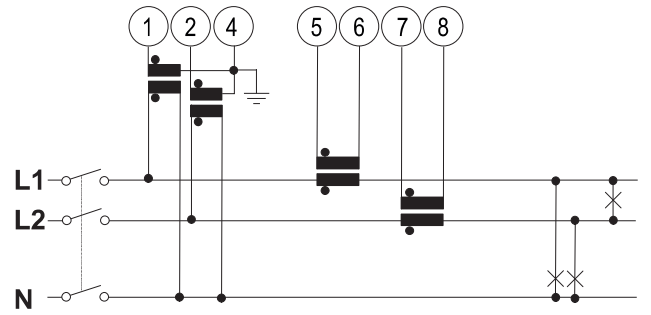

Fig. 8

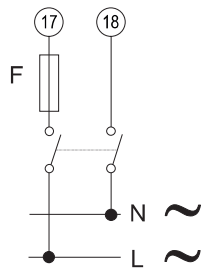

Fig. 9

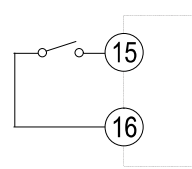

Fig. 10

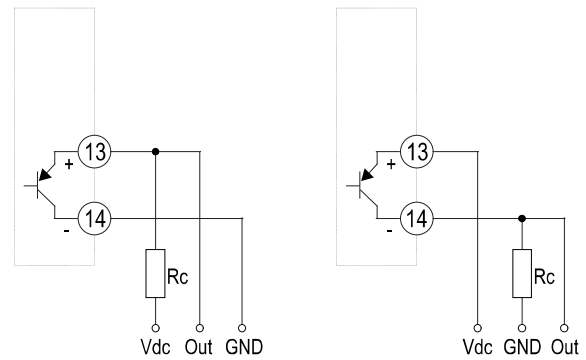

Fig. 11

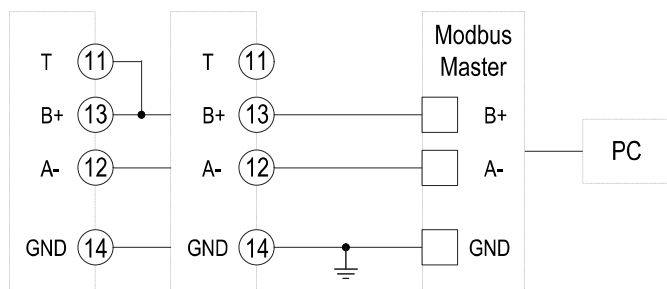

Fig. 12

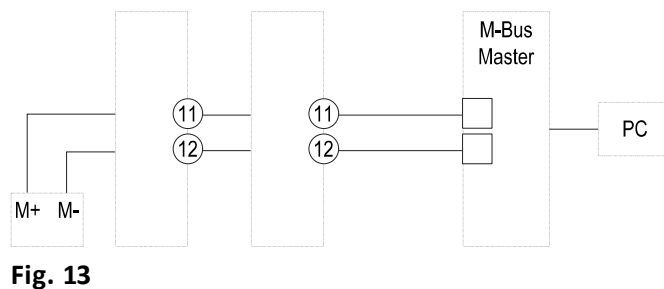

Fig. 13

## Connection diagram (Fig. 3–Fig. 13)

Figure	Description
Fig. 3	Three-phase system current, 4-wire, unbalanced load and three current transformers (TA). 315 mA fuse (F).
Fig. 4	Three-phase system current, 4-wire, unbalanced load, three current transformers (TA) and three voltage transformers (TV)
Fig. 5	Three-phase system current, 3-wire, unbalanced load and three current transformers (TA). 315 mA fuse (F).
Fig. 6	Three-phase system current, 3-wire, unbalanced load, three current transformers (TA) and two voltage transformers (TV)
Fig. 7	Two-phase system current, 3-wire and two current transformers (TA). 315 mA fuse (F).
Fig. 8	Two-phase system current, 3-wire, two current transformers (TA) and two voltage transformers (TV)
Fig. 9	Auxiliary power supply
Fig. 10	Digital input. Open contact = tariff 1, closed contact = tariff 2.
Fig. 11	<p>Pulse output (two possible connections)</p> <p><b>VDC:</b> external voltage (direct current)</p> <p><b>Out:</b> output contact (transistor PNP open collector)</p> <p><b>GND:</b> ground output contact (transistor PNP open collector)</p> <p>Open collector outputs: the load resistance (<math>R_c</math>) must be designed so that the closed contact current is under 100 mA (<math>V_{on}</math> is equal to 1 V dc). DC voltage (<math>V_{off}</math>) must be less than or equal to 80 V.</p>
Fig. 12	<p>RS485 Modbus with Master</p> <p><i>Note: additional instruments with RS485 are connected in parallel. The serial output must only be terminated on the last network device connecting terminals <b>B+</b> and <b>T</b>. For connections longer than 1000 m or networks with more than 160 instruments, use a signal repeater.</i></p>
Fig. 13	M-Bus with Master

## Connection check

The analyzer checks whether connections are correct and signals any faults.

The check can be disabled using the **Install** parameter, see "**Parameters (Fig. 17)**" on page 9.



### Initial assumptions

The check is based on some initial assumptions on the system to be measured. Specifically, it is assumed that each system phase is characterized by:

- a load with  $PF > 0.766$  ( $< 40^\circ$ ) power factor if inductive or  $PF > 0.996$  ( $< 5^\circ$ ) if capacitive
- current at least equal to 10% rated current (primary current transformer)

### Controls and signals

Following are the controls in the order in which they are run and corresponding signals:

Control	Signal
Voltage order	
Voltage and current correspondence. x, y = number of current phases connected to a non corresponding voltage.	$xy$ 
Current direction *. Check phase 1 first, then 2 and lastly 3. x = number of phases involved in the fault	x 

**NOTE** \*: control only run if the imported and exported energies are measured separately (**Measure = b**).

# Using the analyzer

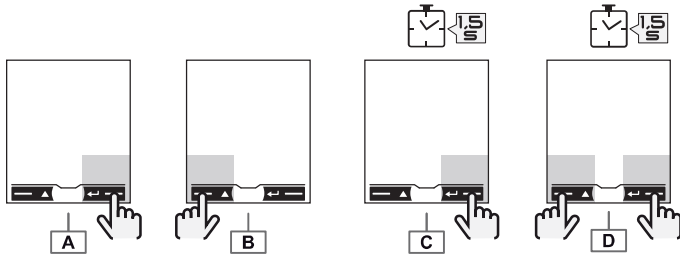

Fig. 14

## Commands (Fig. 14)

### Navigation

Operation	Command
View the next page	<b>A</b>
View the previous page	<b>B</b>
Open the programming section	<b>C</b>
Exit the programming section	<b>C (page End)</b>
Open the information section	<b>D</b>
Exit the information section	<b>D</b>

### Parameter settings

Operation	Command
Increase a parameter value	<b>A</b>
View the next value option	<b>A</b>
Decrease a parameter value	<b>B</b>
View the previous value option	<b>B</b>
Confirm a value	<b>C</b>
Open the parameter settings page	<b>C</b>

## Navigation (Fig. 15)

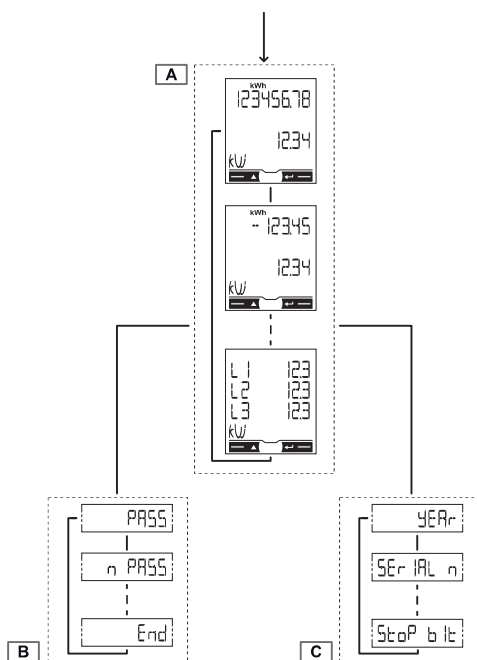

Fig. 15

Section	Function
<b>A</b>	Measurement pages displayed by default when turned on. Pages are characterized by the reference unit of measure.
<b>B</b>	Parameter settings pages. Require login password.
<b>C</b>	The pages display information and set parameters without having to enter a password.

*NOTE: the initial measurement page set in **HOME** is displayed after 120 s of disuse.*

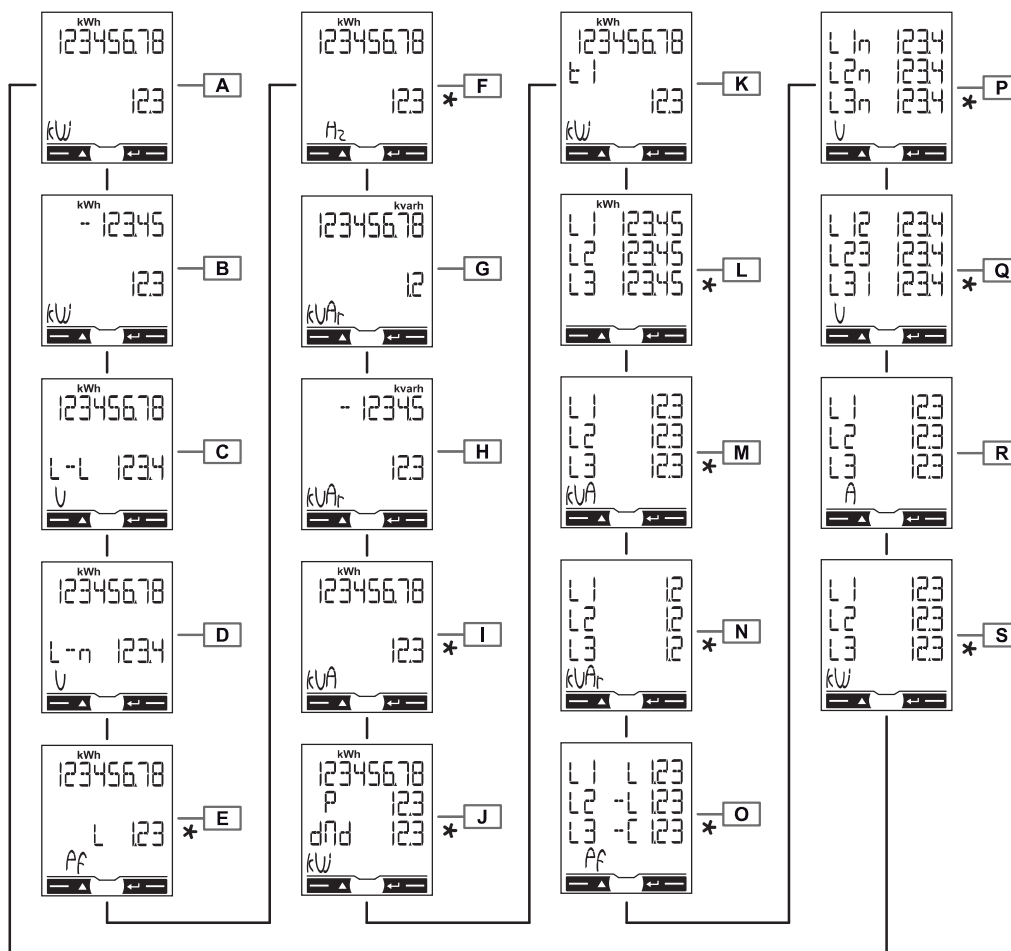

Fig. 16

## Measurement (Fig. 16)

NOTE \*: only displayed if full display mode is set (**Mode = Full**).

### General measurement pages

Page	Description	Code
A	<ul style="list-style-type: none"> <li>Total imported active energy**</li> <li>Total active power</li> </ul>	00
B	<ul style="list-style-type: none"> <li>Total exported active energy***</li> <li>Total active power</li> </ul>	01
C	<ul style="list-style-type: none"> <li>Total imported active energy**</li> <li>Average system mains voltage</li> </ul>	02
D	<ul style="list-style-type: none"> <li>Total imported active energy**</li> <li>Average system phase voltage</li> </ul>	03
E	<ul style="list-style-type: none"> <li>Total imported active energy**</li> <li>Power factor (L = inductive, C = capacitive)</li> </ul>	04
F	<ul style="list-style-type: none"> <li>Total imported active energy**</li> <li>Frequency</li> </ul>	05
G	<ul style="list-style-type: none"> <li>Total imported reactive energy**</li> <li>Total reactive power</li> </ul>	06
H	<ul style="list-style-type: none"> <li>Total exported reactive energy***</li> <li>Total reactive power</li> </ul>	07

Page	Description	Code
I	<ul style="list-style-type: none"> <li>Total imported active energy**</li> <li>Total apparent power</li> </ul>	08
J	<ul style="list-style-type: none"> <li>Total imported active energy**</li> <li>Requested average power (<b>d</b> = demand) calculated for the set interval. The value remains the same for the entire interval. It is = 0 during the first start up interval.</li> <li>Maximum requested power (<b>Pd</b> = Peak demand) reached since last reset</li> </ul>	09
K	<ul style="list-style-type: none"> <li>Total imported active energy**</li> </ul>	10
	<ul style="list-style-type: none"> <li>Current tariff (<b>t1</b> = tariff 1, <b>t2</b> = tariff 2). Displayed if tariff management is on (<b>Tariff</b> = on).</li> <li>Active energy imported with the current tariff. Displayed if tariff management is on (<b>Tariff</b> = on).</li> </ul>	11

NOTE \*\*: if easy connection is on (**Measure** = A), it indicates total reactive energy without considering the direction.

NOTE \*\*\*: displays whether imported and exported energy are measured separately (**Measure** = b).

### Single phase measurement pages

NOTE: the phase measurement pages and indicated information for each depend on the type of system analyzed.

Page	Description	Code
L	Imported active energy. If <i>easy connection</i> is on ( <b>Measure</b> = A), it indicates total energy without considering the direction.	12
M	Apparent power	13
N	Imported reactive energy	14
O	Power factor ( <b>L</b> = inductive, <b>C</b> = capacitive)	15
P	Phase voltage	16
Q	Mains voltage	17
R	Current	18
S	Active power	19

### Measurement faults

If the measured signal exceeds the admitted analyzer limits, a specific message appears:

- **EEE** blinking: the measured value is out of limits
- **EEE** on: the measurement depends on a value that is out of limits

NOTE: active and reactive energy measurements are displayed but do not change.



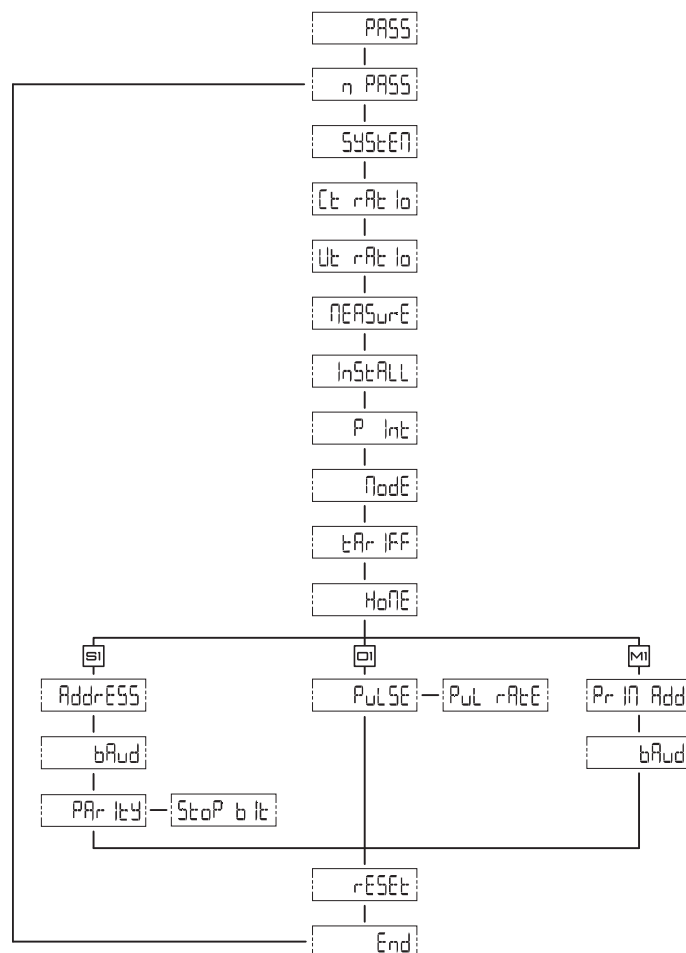

Fig. 17

## Parameters (Fig. 17)

### Shared pages

Page	Code	Description	Values
PASS	P1	Enter current password	Current password. 0000 default password.
nPASS	P2	Change password	Four digits (0000–9999)
SYStEM	P3	System type	<b>3Pn</b> : three phase system, 4-wire/ <b>3P</b> : three-phase system, 3-wire/ <b>2P</b> : two-phase system, 3-wire
Ct rAtIo	P4	Current transformer ratio (TA)	1–1000 *
Vt rAtIo	P5	Voltage transformer ratio (TV)	1–1000 *
<i>NOTE *: the result of the ratio between the current and voltage transformers must be under 1054 for AV5 analyzers and under 3148 for AV6.</i>			
MEASurE	P6	Measurement type	<b>A</b> : easy connection, measures total energy without considering the direction/ <b>b</b> : separately measures imported and exported energy
InStALL	P7	Connection check	<b>On</b> : enabled/ <b>Off</b> : disabled
P int	P8	Average power calculation interval (minutes)	1–30
MOdE	P9	Display mode	<b>Full</b> : complete mode/ <b>Easy</b> : reduced mode. Measurements not displayed are still sent via serial port.
tArIFF	P10	Tariff management	<b>On</b> : enabled/ <b>Off</b> : disabled

Page	Code	Description	Values
HoME	P11	Measurement page displayed when turned on and after 120 seconds of disuse	For full display mode ( <b>Mode</b> = Full): 0–19 For reduced display mode ( <b>Mode</b> = Easy): 0–3, 6, 7, 10/11, 18 To learn the page code see " <b>Measurement (Fig. 16)</b> " on page 7.
rESET	P17	Enable energy tariff, maximum requested power and partial active and reactive energy reset (the latter only sent via serial port)	<b>No</b> : cancel reset/ <b>Yes</b> : enable reset
End	P18	Return to the initial measurement page	–

### Pages specific to the S1 version

Page	Code	Description	Values
AddrESS	P14	Modbus address	1–247
bAUd	P15	Baud rate (kbps)	<b>9.6/ 19.2/ 38.4/ 57.6/ 115.2</b>
PARITY	P16	Parity	<b>Even/ No</b>
STOP bit	P16–2	Only if no parity. Stop bit.	<b>1/ 2</b>

### Pages specific to the O1 version

Page	Code	Description	Values
PULSE	P12	Pulse time (ON time, milliseconds)	<b>30/ 100</b>
PulrAtE	P12–2	Pulse weight. Multiples of 100 impulses/kWh.	For 30 ms: 100–2000 For 100 ms: 100–500

### Pages specific to the M1 version

Page	Code	Description	Values
Pr I Add	P13	M-Bus primary address	1–250
bAUd	P15	Baud rate (kbps)	<b>0.3/ 2.4/ 9.6</b>

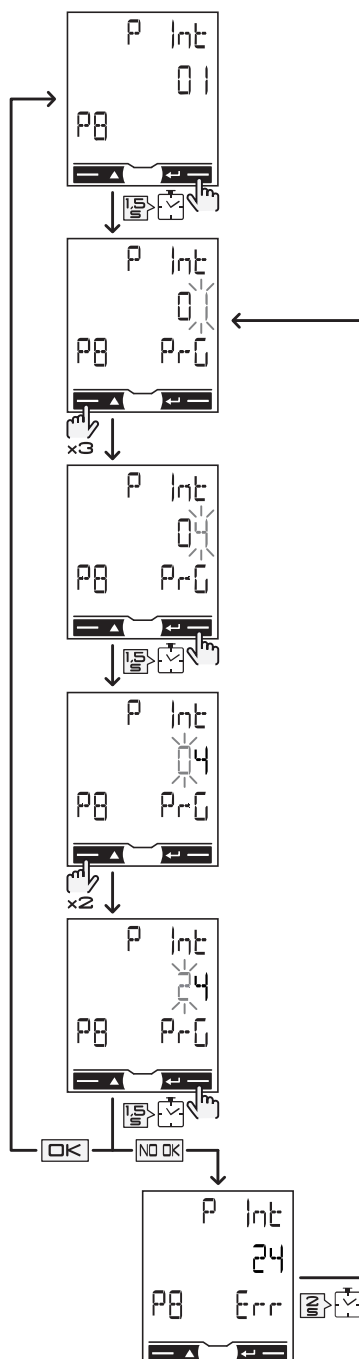

Fig. 18

## Setting a parameter (Fig. 18)

Procedure example: how to set **P int**=24.

*NOTE: the first displayed value is the current one. Settings are applied when the value is confirmed. The value is being edited if **PrG** appears, the set value is out of range if **Err** appears. After 120 s of disuse on a value being set, the title page is displayed (**P int** in the figure) and **PrG** disappears. After another 120 s, the measurement page set in **HoME** returns.*

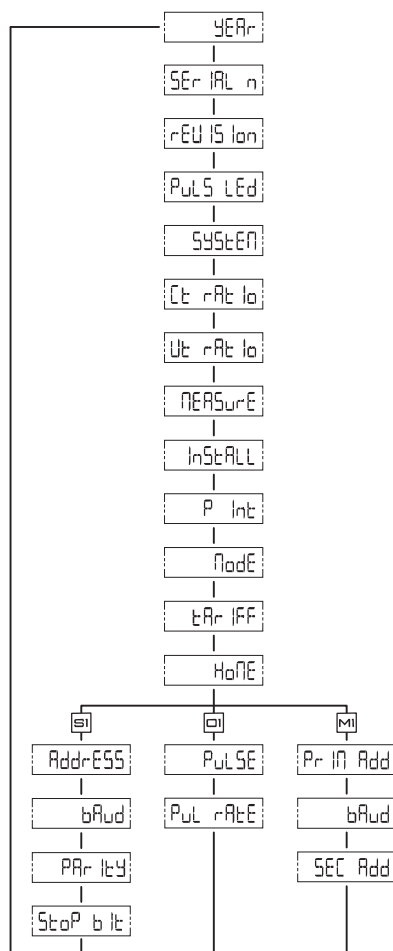

Fig. 19

## Information (Fig. 19)

### Shared pages

Page	Code	Description
YEAr	InFO 1	Year of manufacture
SERIAL n	InFO 2	Serial number, corresponds to the one indicated on the front print, without the initial 'K'
rEVIStion	InFO 3	Firmware revision – A.XX: <ul style="list-style-type: none"> <li>• A= pulse output, B= Modbus serial C= M-Bus serial</li> <li>• XX = sequential revision number (i.e.: 00, 01, 02)</li> </ul>
PuLS Led	InFO 4	Front LED pulse weight, proportionate to the result of the TA and TV ratio, see " <b>Technical Specifications</b> " on page 14.
SYStEM	P3	System type
Ct rAtIo	P4	Current transformer ratio (TA)
Vt rAtIo	P5	Voltage transformer ratio (TV)
MEASurE	P6	Measurement type
InStALL	P7	Enabling connection check
P int	P8	Requested average power calculation interval
ModE	P9	Display mode
tArIFF	P10	Enabling tariff management status and any current tariff
HoME	P11	Measurement page set as home page

### Pages specific to the S1 version

Page	Code	Description
AddrESS	P14	Modbus address, 01 by default
bAUd	P15	Baud rate
PARITY	P16	Parity
StoP bit	P16-2	Stop bit

### Pages specific to the O1 version

Page	Code	Description
PULSE	P12	Duration
PuL rAtE	P12-2	Pulse weight

### Pages specific to the M1 version

Page	Code	Description
Pr I Add	P13	M-Bus primary address
bAUd	P15	Baud rate
SEC Add	InFO 5	M-Bus secondary address, univocal and set during production

# Technical Specifications

## Electrical specifications

Power	Auxiliary power supply H: 90–260 V ac/dc L: 12–60 V ac/dc
Consumption	≤ 1 W, ≤ 10 VA
Base current	5 A
Maximum current	6 A
Minimum current	0.25 A
Start up current	0.01 A
Working voltage	AV5: 400 V ac (mains voltage) AV6: 208–230 V ac (mains voltage)
Frequency	45–65 Hz
Accuracy class	Active energy: <ul style="list-style-type: none"> <li>Class 1 (EN62053-21)</li> <li>Class B (EN50470-3)</li> </ul> Reactive energy: <ul style="list-style-type: none"> <li>Class 2 (EN62053-23)</li> </ul>

## Environmental specifications

Working temperature	From -25 to +55 °C/from -13 to +131 °F
Storage temperature	From -30 to +80 °C/from -22 to +176 °F

## Output specifications

Pulse output	Proportionate to measured active energy (EN62052-31)
Modbus RS485 port output	Modbus RTU protocol
M-Bus port output	M-Bus protocol, (EN13757-1)

*NOTE: to set output parameters, see "Parameters (Fig. 17)" on page 9.*

## LED specifications

Pulse weight	Proportionate to the result of TA and TV ratios:	
	Weight (impulses/kWh)	TA * TV
	1	> 700.1
	10	70.1–700
	100	7.1–70
	1000	< 7
Duration	90 ms	
Color	Red and orange	

Terminals	1–4, 17, 18: section 1–4 mm <sup>2</sup> , torque 0.4 Nm 5–16: section 1.5 mm <sup>2</sup> , torque 0.4 Nm
Protection grade	Front: IP51, terminals: IP20
Dimensions	See Fig. 20

## General features

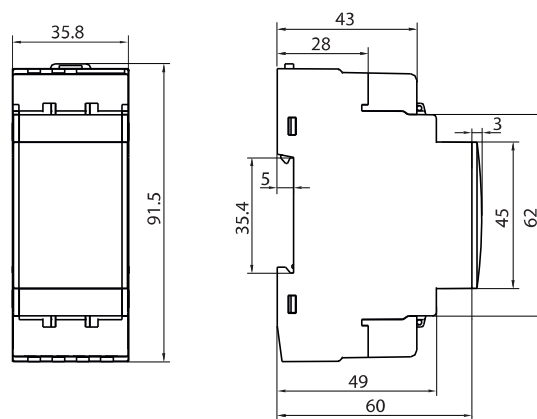

Fig. 20

## Cleaning

Use a slightly dampened cloth to clean the instrument display; do not use abrasives or solvents.

## Service and warranty

In the event of malfunction, fault or for information on the warranty, contact the CARLO GAVAZZI branch or distributor in your country.

## Conformity

*NOTE: for updated information [www.gavazziautomation.com](http://www.gavazziautomation.com).*



- 2006/95/EC (Low Voltage)
- 2004/108/EC (Electro Magnetic Compatibility)

- EN 61010-1
- EN 61000 6-1, 6-3
- IEC 60417-5172
- IEC 60664
- IP51

EM330

Installation and use instructions | 8021422

COPYRIGHT ©2014

download the PDF: [www.productselection.net](http://www.productselection.net)

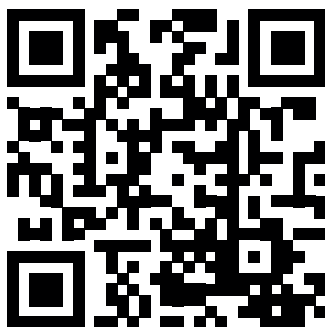

**CARLO GAVAZZI Controls SpA**

via Safforze, 8  
32100 Belluno (BL) Italy

[www.gavazziautomation.com](http://www.gavazziautomation.com)  
[info@gavazzi-automation.com](mailto:info@gavazzi-automation.com)

**info:** +39 0437 355811  
**fax:** +39 0437 355880