

**Inductive sensor**  
**With increased switching distance**  
**BI4-M12-AP6X-H1141**

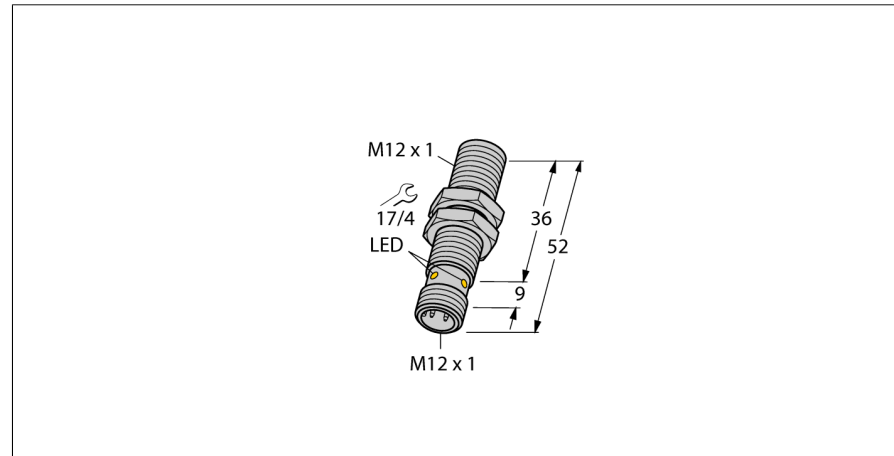

- M12 × 1 threaded barrel
- Chrome-plated brass
- Large sensing range
- DC 3-wire, 10...30 VDC
- NO contact, PNP output
- M12 x 1 male connector

**Wiring Diagram**

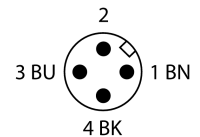
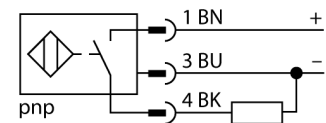

|   |   |
|---|---|
| <b>Type designation</b>                   | BI4-M12-AP6X-H1141                                  |
| Ident no.                                 | 46070   |
| <b>Rated switching distance Sn</b>        | 4 mm  |
| Mounting conditions                       | Flush   |
| Secured operating distance                | ≤ (0,81 x Sn) mm                                    |
| Correction factors                        | St37 = 1; Al = 0.3; stainless steel = 0.7; Ms = 0.4 |
| Repeat accuracy                           | ≤ 2 % of full scale                                 |
| Temperature drift                         | ≤ ± 10 %  |
| Hysteresis                                | 3...15 %  |
| Ambient temperature                       | -25...+70 °C  |
| <b>Operating voltage</b>                  | 10...30 VDC   |
| Residual ripple                           | ≤ 10 % U <sub>ss</sub>                              |
| DC rated operational current              | ≤ 200 mA  |
| No-load current I <sub>0</sub>            | ≤ 15 mA   |
| Residual current                          | ≤ 0.1 mA  |
| Isolation test voltage                    | ≤ 0.5 kV  |
| Short-circuit protection                  | yes/ Cyclic   |
| Voltage drop at I <sub>0</sub>            | ≤ 1.8 V   |
| Wire breakage/Reverse polarity protection | yes/ Complete                                       |
| Output function                           | 3-wire, NO contact, PNP                             |
| Protection class                          | ☐   |
| Switching frequency                       | 2 kHz   |
| <b>Design</b>                             | Threaded barrel, M12 × 1                            |
| Dimensions                                | 52 mm   |
| Housing material                          | Metal, CuZn, Chrome-plated                          |
| Active area material                      | Plastic, PA12-GF30                                  |
| Max. tightening torque housing nut        | 10 Nm   |
| Electrical connection                     | Connectors, M12 × 1                                 |
| Vibration resistance                      | 55 Hz (1 mm)  |
| Shock resistance                          | 30 g (11 ms)  |
| Protection class                          | IP67  |
| MTTF                                      | 2283 years acc. to SN 29500 (Ed. 99) 40 °C          |
| Packaging unit                            | 1   |
| <b>Switching state</b>                    | LED, Yellow   |

**Functional principle**

Inductive sensors detect metal objects contactless and wear-free. For this, they use a high-frequency electromagnetic AC field that interacts with the target. Inductive sensors generate this field via an RLC circuit with a ferrite coil.

**Inductive sensor**  
**With increased switching distance**  
**BI4-M12-AP6X-H1141**

|                        |         |
|------------------------|---------|
| Distance D             | 24 mm   |
| Distance W             | 3 x Sn  |
| Distance T             | 3 x B   |
| Distance S             | 1.5 x B |
| Distance G             | 6 x Sn  |
| Diameter active area B | Ø 12 mm |



**Inductive sensor  
With increased switching distance  
BI4-M12-AP6X-H1141**

**Accessories**

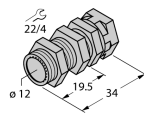
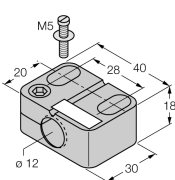
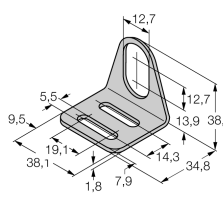
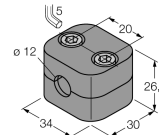
| Type code | Ident no. | Description  |   |
|-----------|-----------|--|---|
| QM-12     | 6945101   | Quick-mount bracket with dead-stop; material: Chrome-plated brass Male thread M16 x 1. Note: The switching distance of proximity switches can be reduced by the use of quick-mount brackets. |    |
| BST-12B   | 6947212   | Fixing clamp for threaded barrel devices, with dead-stop; material: PA6  |    |
| MW-12     | 6945003   | Mounting bracket for threaded barrel devices; material: Stainless steel A2 1.4301 (AISI 304)   |  |
| BSS-12    | 6901321   | Mounting bracket for smooth and threaded barrel devices; material: Polypropylene   |  |

**Wiring accessories**

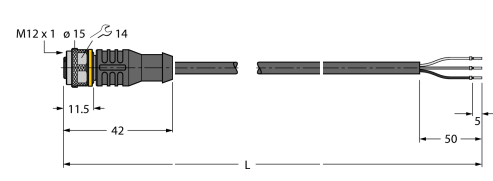
| Type code   | Ident no. | Description  |   |
|-------------|-----------|--|---|
| RKC4T-2/TEL | 6625010   | Connection cable, female M12, straight, 3-pin, cable length: 2 m, sheath material: PVC, black; cULus approval; other cable lengths and qualities available, see <a href="http://www.turck.com">www.turck.com</a> |  |