

Inductive sensor
With increased switching distance
BI4-M12-VP6X-H1141

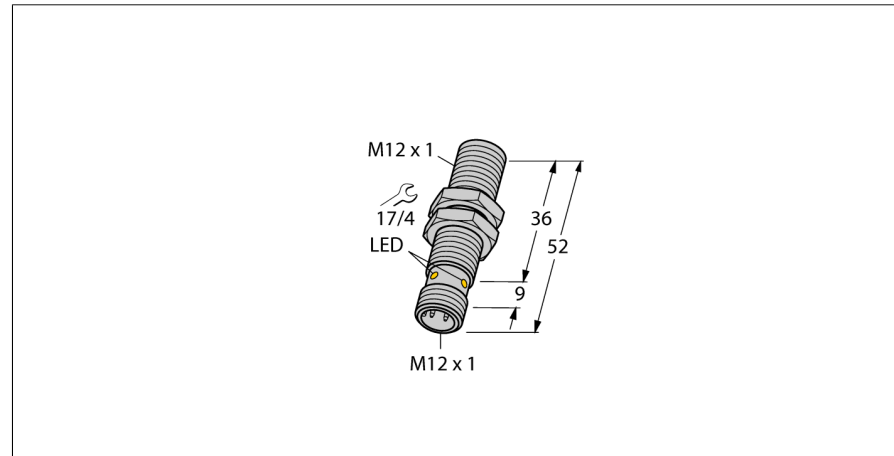

- M12 × 1 threaded barrel
- Chrome-plated brass
- Large sensing range
- DC 4-wire, 10...30 VDC
- Changeover contact, PNP output
- M12 x 1 male connector

Wiring Diagram

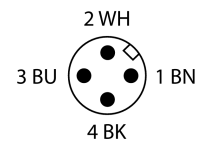
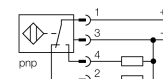

Type designation	BI4-M12-VP6X-H1141
Ident no.	1633200
Rated switching distance Sn	4 mm
Mounting conditions	Flush
Secured operating distance	≤ (0,81 x Sn) mm
Correction factors	St37 = 1; Al = 0.3; stainless steel = 0.7; Ms = 0.4
Repeat accuracy	≤ 2 % of full scale
Temperature drift	≤ ± 10 %
Hysteresis	3...15 %
Ambient temperature	-25...+70 °C
Operating voltage	10...30 VDC
Residual ripple	≤ 10 % U _{ss}
DC rated operational current	≤ 200 mA
No-load current I ₀	≤ 15 mA
Residual current	≤ 0.1 mA
Isolation test voltage	≤ 0.5 kV
Short-circuit protection	yes/ Cyclic
Voltage drop at I ₀	≤ 1.8 V
Wire breakage/Reverse polarity protection	yes/ Complete
Output function	4-wire, Complementary contact, PNP
Switching frequency	2 kHz
Design	Threaded barrel, M12 × 1
Dimensions	52 mm
Housing material	Metal, CuZn, Chrome-plated
Active area material	Plastic, PA12-GF30
Max. tightening torque housing nut	10 Nm
Electrical connection	Connectors, M12 × 1
Vibration resistance	55 Hz (1 mm)
Shock resistance	30 g (11 ms)
Protection class	IP67
MTTF	2283 years acc. to SN 29500 (Ed. 99) 40 °C
Packaging unit	1
Switching state	LED, Yellow

Functional principle

Inductive sensors detect metal objects contactless and wear-free. For this, they use a high-frequency electromagnetic AC field that interacts with the target. Inductive sensors generate this field via an RLC circuit with a ferrite coil.

Inductive sensor
With increased switching distance
BI4-M12-VP6X-H1141

Distance D	24 mm
Distance W	3 x Sn
Distance T	3 x B
Distance S	1.5 x B
Distance G	6 x Sn
<hr/>	
Diameter active area B	Ø 12 mm



**Inductive sensor
With increased switching distance
BI4-M12-VP6X-H1141**

Accessories

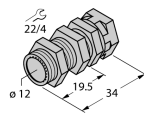
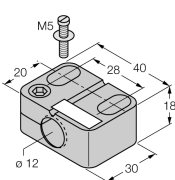
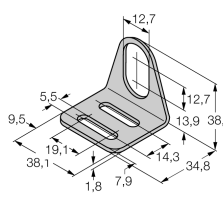
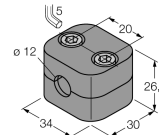
Type code	Ident no.	Description	
QM-12	6945101	Quick-mount bracket with dead-stop; material: Chrome-plated brass Male thread M16 x 1. Note: The switching distance of proximity switches can be reduced by the use of quick-mount brackets.	
BST-12B	6947212	Fixing clamp for threaded barrel devices, with dead-stop; material: PA6	
MW-12	6945003	Mounting bracket for threaded barrel devices; material: Stainless steel A2 1.4301 (AISI 304)	
BSS-12	6901321	Mounting bracket for smooth and threaded barrel devices; material: Polypropylene	

Wiring accessories

Type code	Ident no.	Description	
RKC4.4T-2/TEL	6625013	Connection cable, female M12, straight, 4-pin, cable length: 2 m, sheath material: PVC, black; cULus approval; other cable lengths and qualities available, see www.turck.com	