

BI5-M18-AD4X

Inductive sensor

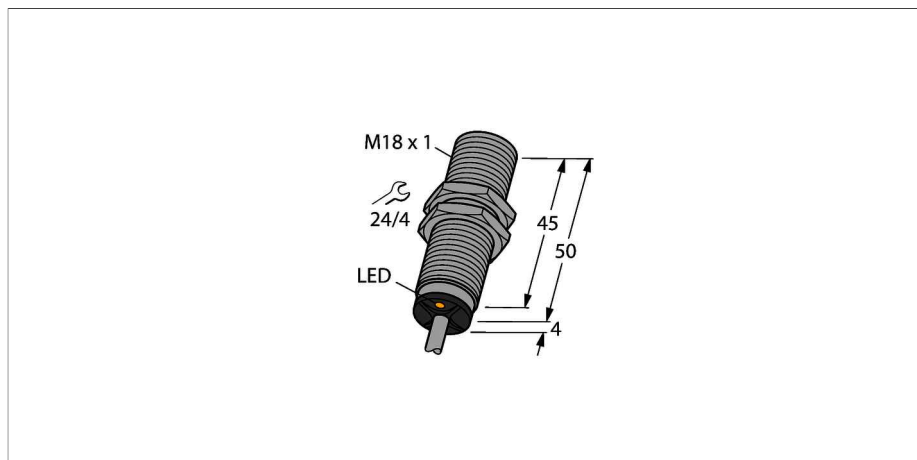

Features

- Threaded barrel, M18 x 1
- Chrome-plated brass
- DC 2-wire, 10...65 VDC
- NO contact
- Cable connection

Wiring diagram

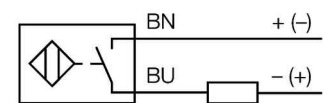

Inductive sensors detect metal objects contactless and wear-free. For this, they use a high-frequency electromagnetic AC field that interacts with the target. Inductive sensors generate this field via an RLC circuit with a ferrite coil.

Technical data

Type	BI5-M18-AD4X
ID number	44110
Rated switching distance	5 mm
Mounting conditions	Flush
Secured operating distance	$\leq (0,81 \times S_n)$ mm
Correction factors	St37 = 1; Al = 0.3; stainless steel = 0.7; Ms = 0.4
Repeat accuracy	$\leq 2\%$ of full scale
Temperature drift	$\leq \pm 10\%$
Hysteresis	1...15 %
Ambient temperature	-25...+70 °C
Operating voltage	10...65 VDC
Residual ripple	$\leq 10\% U_{ss}$
DC rated operational current	≤ 100 mA
Residual current	≤ 0.6 mA
Isolation test voltage	≤ 0.5 kV
Short-circuit protection	yes / Cyclic
Voltage drop at	≤ 5 V
Wire breakage/Reverse polarity protection	Complete
Output function	NO contact, 2-wire
Smallest operating current	≥ 3 mA
Switching frequency	1 kHz
Design	Threaded barrel, M18 x 1
Dimensions	54 mm
Housing material	Metal, CuZn, Chrome-plated
Active area material	Plastic, PA12-GF30
End cap	Plastic, EPTR
Max. tightening torque housing nut	25 Nm

Technical data

Electrical connection	Cable
Cable quality	Ø 5.2 mm, LifYY, PVC, 2 m
Cable cross section	2 x 0.34 mm ²
Vibration resistance	55 Hz (1 mm)
Shock resistance	30 g (11 ms)
Protection class	IP67
MTTF	2283 years acc. to SN 29500 (Ed. 99) 40 °C
Switching state	LED yellow

Mounting instructions/Description

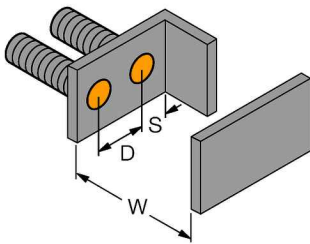
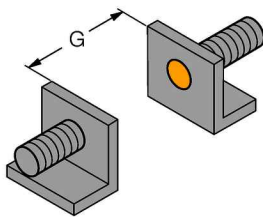
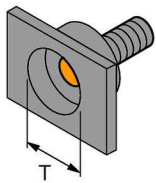

Distance D	2 x B
Distance W	3 x Sn
Distance T	3 x B
Distance S	1.5 x B
Distance G	6 x Sn
Diameter active area B	Ø 18 mm

Mounting accessories

BST-18B 6947214

Fixing clamp for threaded barrel devices, with dead-stop; material: PA6

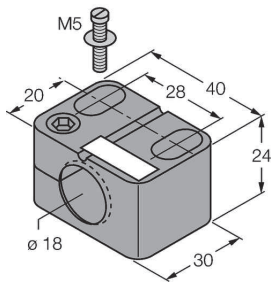

QM-18 6945102

Quick-mount bracket with dead-stop; material: Chrome-plated brass Male thread M24 x 1.5. Note: The switching distance of proximity switches can be reduced by the use of quick-mount brackets.

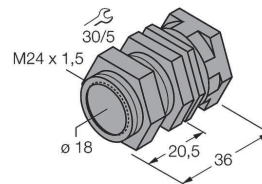

MW-18 6945004

Mounting bracket for threaded barrel devices; material: Stainless steel A2 1.4301 (AISI 304)

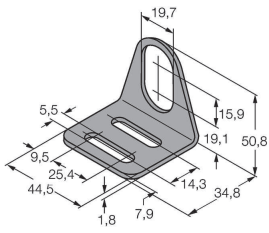

BSS-18 6901320

Mounting bracket for smooth and threaded barrel devices; material: Polypropylene

