

## TI-S Series

Measurement range:  
-40 to +500°C

Sensor Head TI-S30

Controller TI-SC (E)



# High-Speed & High-Accuracy Non-Contact Thermometer with Visible Field of View

**Unique  
Technology**

Equipped with a ring laser marker to improve work efficiency

**First in  
Industry**

Measured temperature can be checked in a trend graph

**Improved  
Performance**

High-accuracy measurement:  $\pm 1^\circ\text{C}$   
Response time: Achieves 50 ms or less





# Performance and ease of use to meet your needs in the field

## A new standard for non-contact thermometers

[Easy adjustment]

### **First in Industry** Ring laser marker for easy positioning

A ring laser marker is installed as standard. The ring laser marker visually indicates the measurement position and measurement field of view.

This allows you to make position adjustments easily while checking the measurement field of view, even in dark and small spaces. (Patent pending)

### IO-Link communication supported IO-Link

IO-Link enables bidirectional communication between the controller level and device level on a point to point basis. The measured temperature can be monitored directly as digital values without analog conversion.

[High performance]

### High-accuracy measurement ±1°C

Measurement can be performed with an accuracy of ±1°C. This thermometer can also meet stringent measurement requirements.

\* Measurement range: 1 to 200°C

### High speed

Achieves response times of 50 ms or less (high speed) with 90% response. So it is also effective for applications such as measuring the temperature of objects on a production line.

Edge detection allows for immediate detection when rapid temperature changes occur.

### ■ Applications

Detecting presence of hot-melt adhesive



Evaluating solar panel lamination



Measuring temperature of chamber top plate



# Flexible installation and easy operation

[Sensor Head]

## Compact design

The compact (49 × 35 × 23 mm) size allows for installation even in small spaces.

## Environmental resistance

Heat resistance up to an ambient temperature of 80°C (70°C when using the laser marker), and IP67 degree of protection.

## Easy-to-understand indicators

Errors, warnings, and operating status are indicated by two indicators.



Measuring temperature of plastic

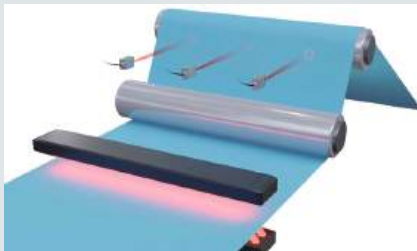

Controlling heating time in tire vulcanization processes



[Controller]

## 1.8-inch full color TFT LCD

It is possible to display English, Simplified Chinese, and Japanese, which could not be reproduced with a conventional 7-segment LED display. This also allows settings to be configured easily.

## Screen display can be rotated

The controller screen display can be rotated 360° in 90° increments, so the controller can be installed without worrying about the installation direction.

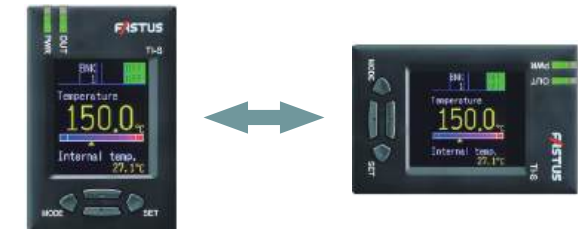

Measuring temperature in rubber extrusion processes



# Wide-ranging interface and measurement functions



Visible from status display of sensor head

## Edge detection

### Detection of rapid temperature changes

Edge detection is provided, and detects when rapid temperature changes occurred. It is possible to only detect errors caused by temperature changes occurring within a short period of time.

## Analog output

For analog output, current output (4 to 20 mA) and voltage output (0 to 10 V) can be selected.

It can be used without selecting an input device.

## Alarm output (upper/lower limit settings)

A designated temperature range can be set as the threshold, and an alarm can be output when the measured temperature is outside of that range.



## First in Industry

### Trend graph

A trend graph of the measured temperature can be displayed covering up to 24 hours.

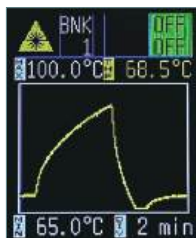

### Head internal temperature display

In addition to the temperature of the measurement target, the head internal temperature is also continuously displayed. This allows use while checking the effects of the ambient temperature.

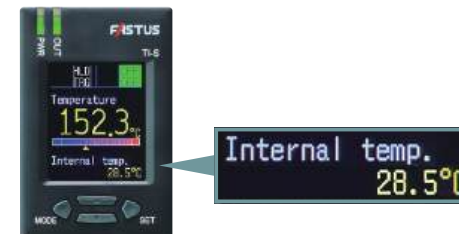

## Best in class in industry

### Stable measurement with respect to ambient temperature fluctuations

Temperature measurement in heating and cooling processes often involves changes in the temperature at the installation environment.

With the TI-S Series, stable continuous measurement is achieved compared with the previous model, even if the ambient temperature fluctuates.

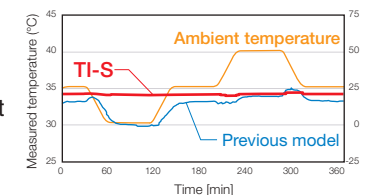

Temperature fluctuations of environment: Within  $\pm 0.25^{\circ}\text{C}/^{\circ}\text{C}$

### Bank function (4 channels)

4 ch are installed for the bank function which can select (call) setting contents. The settings can be easily changed when the measurement condition changes.

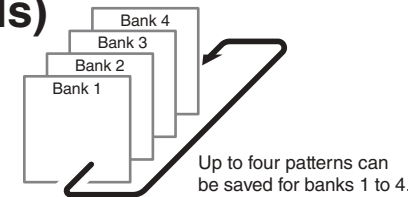

### Maintenance alarm

Notification of maintenance timing can be provided when the preset period has elapsed for the timing of optical system cleaning, calibration, or other maintenance.



Presetting of maintenance timing



Notified automatically when the set time has elapsed.

# IO-Link communication supported IO-Link

## System overview

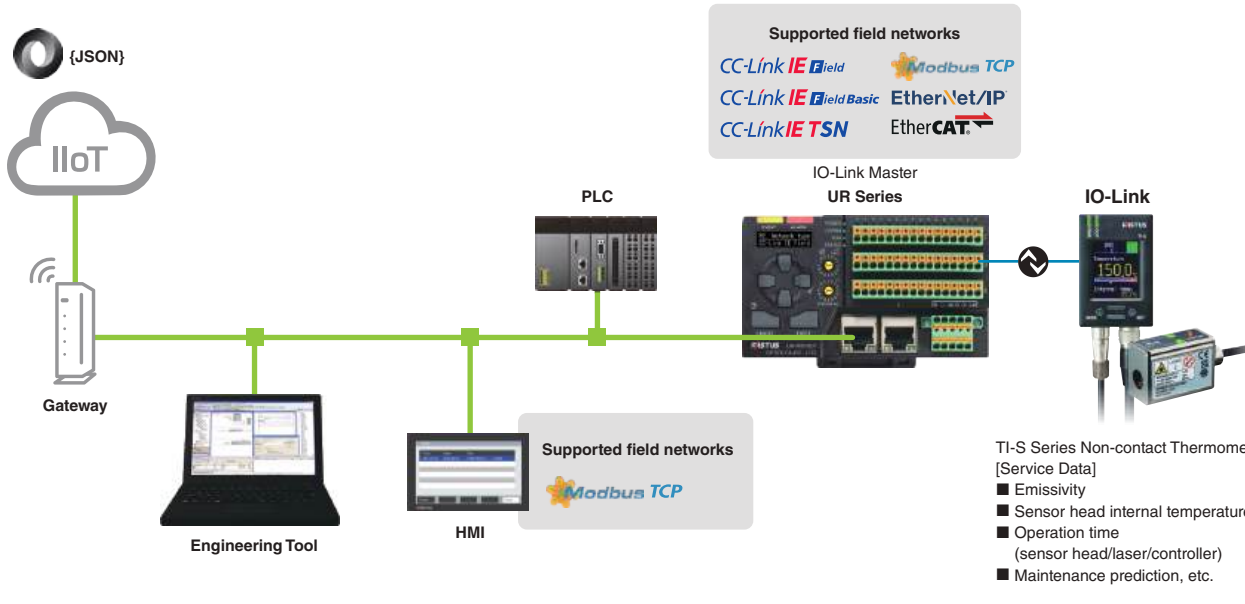

IO-Link is a technology that connects sensors and actuators to Industrial Ethernet using digital signals to promote smart factories. Measurements can be obtained directly as digital values, reducing the need for analog input. Noise resistance, cost reduction, and predictive maintenance are achieved.

## Three advantages of introducing IO-Link

**Advantage 1**



Device information status monitoring leads to predictive maintenance and **reduced downtime**.

**Advantage 2**

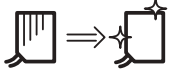

The storage of device information allows for immediate restoration even if the device is replaced, **improving maintainability**.

**Advantage 3**



Converts measured value to digital signals for transmission to PLC, making them **resistant to noise and enabling long-distance communication**.

## Field of view (Unit: mm)

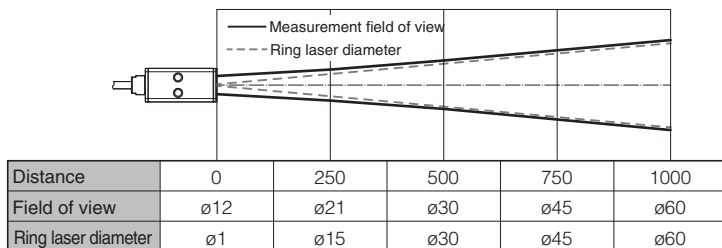

## I/O circuit diagrams

### General-purpose I/O cable

#### NPN setting

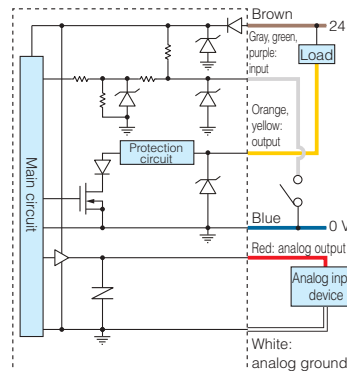

#### PNP setting

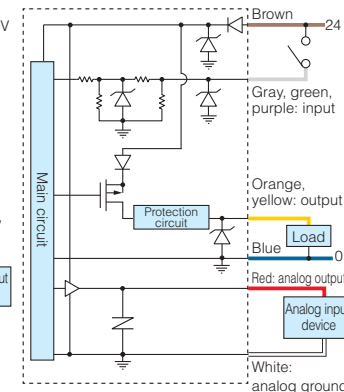

### IO-Link cable

#### IO-Link connection

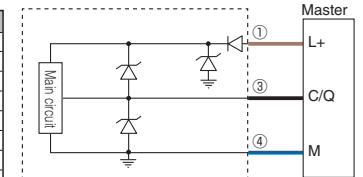

#### Lead wire functions

Wire color	Description
Brown	+V (24 VDC)
Gray	Laser control input
Green	Hold input/bank select*
Purple	Trigger input/bank select*
Orange	Upper limit alarm output
Yellow	Lower limit alarm output
Blue	Ground (0 V)
Red	Analog output
White	Analog ground

\* Operates as bank select input when Measurement mode is set to Normal.

#### Lead wire functions during bank select

Bank number	Lead wire color
1	OFF OFF
2	OFF ON
3	ON OFF
4	ON ON

#### IO-Link cable lead wire/connector pin functions

No.	Wire color	M12 connector pin No.	Description
①	Brown	①	L+
②	-	-	*1
③	Black	④	C/Q
④	Blue	③	M

#### M12 connector pin No.

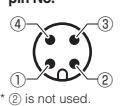

\*1 The input line is replaced with process output data.

# ■ Dimensions (Unit: mm)

## Sensor head

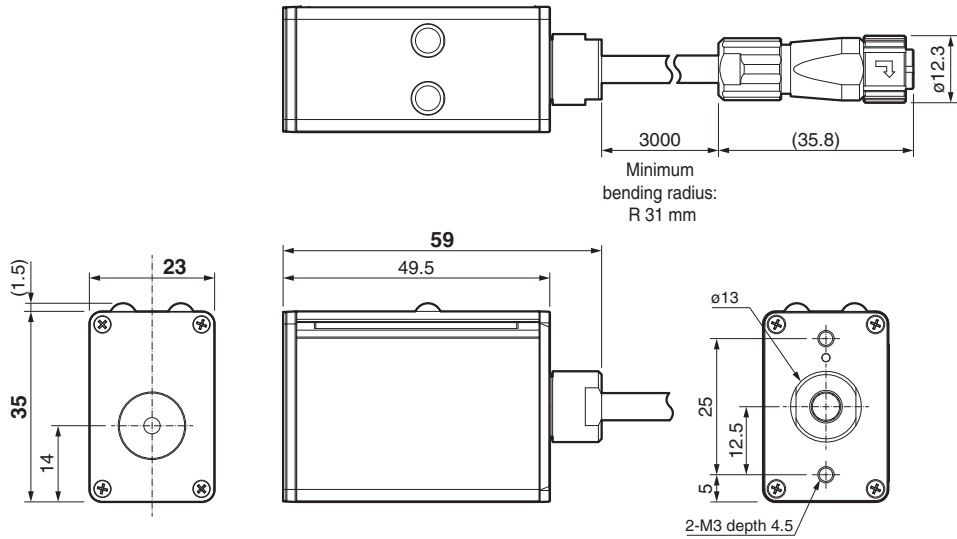

## Controller

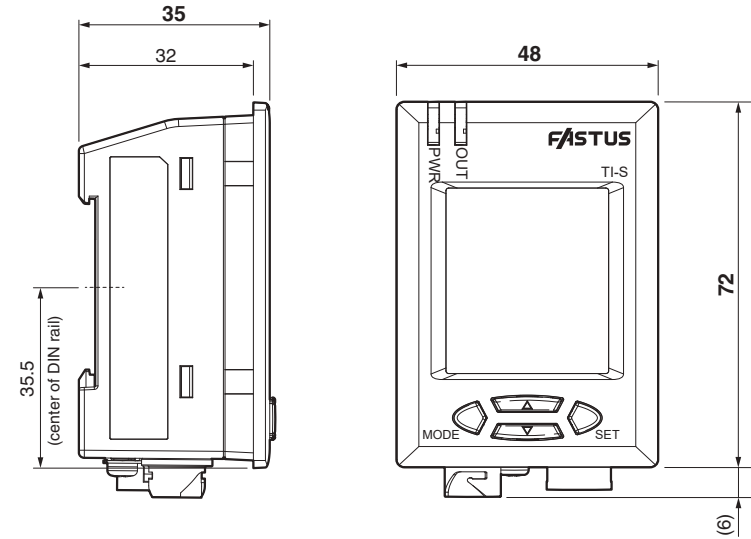

## Connection cable (Option)

General-purpose I/O cable: TI-SCA09-G3K

Minimum bending radius (Stationary position): R 42 mm

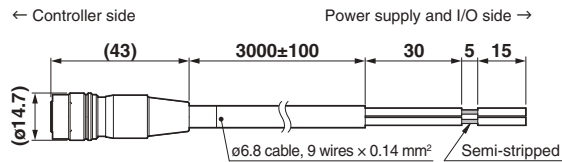

IO-Link cable: TI-SCA03-G3K

Minimum bending radius (Stationary position): R 42 mm

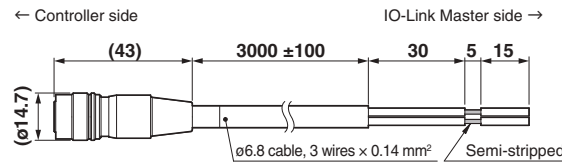

IO-Link cable: TI-SM1203-G03K

Minimum bending radius (Stationary position): R 42 mm

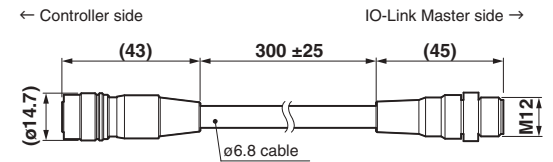

\* For the dimensions of the extension cable and mounting brackets, refer to the OPTEX FA website.

# Options

## ■ Connection cables

\* The controller does not come with a cable to connect an external device.  
To connect the controller with an external device, please purchase one of the following connection cables.

### General-purpose I/O cable

TI-SCA09-G3K Open-end cable

### IO-Link cable

TI-SCA03-G3K Open-end cable  
Minimum bending radius (Stationary position): R 42 mm



### IO-Link cable

TI-SM1203-G03K  
M12 4-pin plug  
Minimum bending radius  
(Stationary position): R 42 mm



## ■ Extension cables

### Extension cable connecting the head and controller

TI-SSA06-G3K (Cable length: 3 m)  
TI-SSA06-G10K (Cable length: 10 m)  
Minimum bending radius (Stationary position): R 31 mm



## ■ Black body tape for non-contact thermometer

HB-250  
Heat resistance temperature: 250°C  
Tape width: 60 mm, Tape length: 2 m



## ■ Mounting brackets

For controller

BKT-OPPD  
(Panel mounting bracket)



For sensor head

BEF-TISH-B  
(Floor mounting bracket)



For sensor head

BEF-TISH-A  
(Wall mounting bracket)



For sensor head

BEF-TISH-AB  
(2-axis mounting bracket)



## ■ Product calibration

The non-contact thermometers of OPTEX FA are calibrated based on our traceability system using a standard traceable to national standards. OPTEX FA can carry out periodic calibration (for a fee) after purchase. If you require calibration certificate documents, we provide a set of three documents: Certificate of Calibration, Report of Calibration, and Traceability Chart.

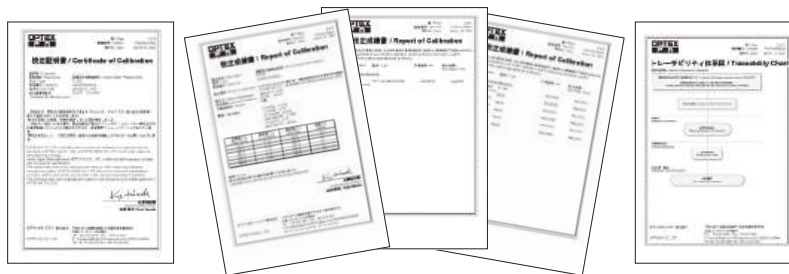

## ■ Sensor head and controller can be replaced individually

The thermometer function is self-contained in the sensor head, so there is no need to calibrate the controller.



# Specifications

## [Sensor Head]

Model	TI-S30
Measurement range	-40 to +500°C
Field of view	ø30 mm at 500 mm
Optics	Silicon lens
Sensing element/spectral response	Thermopile 8 to 14 µm
Response time (operating mode)	High speed response, 50 ms, 100 ms, 200 ms, 500 ms, 1 s, 2 s, 5 s, 10 s, 20 s * Output response 90% <sup>1</sup>
Accuracy <sup>2</sup>	-40 to 0°C: ±1.5°C +1 to +200°C: ±1°C +201 to +500°C: ±0.5% of reading value
Repeatability	±0.5°C (when operating mode is 100 ms)
Temperature drift	Within ±0.25°C/°C
Emissivity adjustment	0.100 to 1.200
Supply voltage	5 VDC (Supplied from controller)
Current consumption	30 mA or less/5 VDC
Connection type	Pigtail cable 3 m
Minimum bending radius	R 31 mm
Total cable length	Maximum 13 m (pigtail cable 3 m + extension cable 10 m)
Laser marker	Medium
Wavelength	663 nm
Maximum output	1 mW
Laser class (JIS/IEC/FDA) <sup>3</sup>	CLASS 2
Environmental resistance	Degree of protection IP67 (IEC 60529) Ambient temperature 0 to +80°C (up to +70°C during laser emission) Ambient humidity 35 to 85% RH (no condensation) Storage temperature -20 to +80°C Vibration resistance 10 to 55 Hz Double amplitude 1.5 mm 2 hours in each of the X,Y and Z directions Shock resistance 500 m/s <sup>2</sup> (Approx. 50 G ) 3 times in each of the X,Y and Z directions
Applicable regulations	EMC EMC Directive (2014/30/EU) UK EMC (The Electromagnetic Compatibility Regulations 2016) FCC Part 15 subpart B Environment RoHS Directive (2011/65/EU), China RoHS (MIIT Order No. 32) UK RoHS (The Restriction of the Use of Certain Hazardous Substances in Electrical and Electronic Equipment Regulations 2012) Safety FDA Regulation (21 CFR 1040.10 and 1040.11 <sup>4</sup> )
Applicable standards	EN/IEC 61326-1
Material	Case: Aluminum, Front plate: Stainless steel
Weight	Approx. 180 g (including connector cable)

\*1: The response time is the time it takes for the output change to reach 90%.

\*2: Measurement conditions: Emissivity: 1.000, Ambient temperature: 23 ±5°C, Size of the measurement target; sufficiently larger than the field of view.

\*3: In accordance with the FDA provisions of Laser Notice No. 56, the laser is classified per the IEC 60825-1:2014 standard.

\*4: Excluding differences per Laser Notice No. 56.

\*5: To convert temperature values such as measurement temperature range and accuracy to Fahrenheit temperature, use (Fahrenheit temperature = Celsius temperature x 1.8 + 32).

\*6: To convert relative values such as repeatability and temperature drift to Fahrenheit temperatures, use 1°C = 1.8°F.



## [Controller]

Model	TI-SC (E)		
Rating	Supply voltage	24 VDC ±10% (when using a general-purpose I/O cable) 18 to 30 VDC (when using an IO-Link cable)	
	Current consumption	180 mA (when using a general-purpose I/O cable) <sup>1</sup> 50 mA (when using an IO-Link cable)	
Display resolution	0.1°C/°F		
Temperature unit	Celsius "°C"/Fahrenheit "°F"		
Measurement mode	Normal/Sample hold/Peak hold/Valley hold/Edge detection		
Response time (operating mode)	High speed/50 ms/100 ms/200 ms/500 ms/1 s/2 s/5 s/10 s/20 s Output response 90% <sup>2</sup>		
Analog output/ IO-Link update time	High speed: 2.5 ms 50 ms to 2 s: 5.0 ms 5 s to 20 s: 100 ms		
Analog output	Resolution	10,801 steps	
	Accuracy	Voltage	±0.2% of F.S. (at ambient temperature of 25°C) Temperature coefficient (typical): ±22 ppm/°C (±0.0022%/°C)
		Current	±0.2% of F.S. (at ambient temperature of 25°C) Temperature coefficient (typical): ±4 ppm/°C (±0.0004%/°C)
Indicator	Display	1.8-inch TFT LCD Display language: English, Simplified Chinese, Japanese	
	Power indicator	When power is ON: lights in green, IO-Link communication: blinks in green	
	Output indicator	Normal measurement alarm output is OFF: lights green Normal measurement alarm output is ON: lights red When minor warning occurs: blinks green When major warning occurs: blinks orange When error occurs: blinks red	
Interface	Alarm output	NPN/PNP open collector (selectable by setting) 1 output: Max. 100 mA, 2 outputs: Max. 100 mA Residual voltage NPN: 1.6 V or less, PNP: 3.4 V or less	
	Output mode	N.O./N.C.	
	External input	Laser off, Hold, Trigger	
Analog output	Current	4 to 20 mA load impedance: 150 to 500 ohm	
	Voltage	0 to 10 V output impedance: 200 ohm or less	
Timer mode	One shot/delay (ON delay, OFF delay) One shot: 0.01 to 10.00 sec, Delay: 0.00 to 10.00 sec		
IO-Link	Revision	1.1.3	
	Baud rate	COM 3 (230.4 kbps)	
	Number of process input data bytes	4 bytes	
	Number of process output data bytes	1 byte	
	Minimum cycle time	0.5 ms	
	Data storage class	Data Storage Class 1: automatic DS	

Model	TI-SC (E)		
Connection type	General-purpose I/O cable	3 m cable 9 wires, Minimum bending radius: R 42 mm	
	IO-Link cable	Open-end	3 m cable 3 wires, Minimum bending radius: R 42 mm
		M12 4-pin connector	0.3 m cable, Minimum bending radius: R 42 mm
Environmental resistance	Degree of protection	IP40 (IEC 60529)	
	Ambient temperature	0 to +50°C	
	Ambient humidity	35 to 85% RH (no condensation)	
	Storage temperature	-20 to +70°C	
	Vibration resistance	10 to 55 Hz Double amplitude 1.5 mm 2 hours in each of the X,Y and Z directions	
Shock resistance		500 m/s <sup>2</sup> (Approx. 50 G ) 3 times in each of the X,Y and Z directions	
	EMC	EMC Directive (2014/30/EU) UK EMC (The Electromagnetic Compatibility Regulations 2016) FCC Part 15 subpart B	
Applicable regulations	Environment	RoHS Directive (2011/65/EU) UK RoHS (The Restriction of the Use of Certain Hazardous Substances in Electrical and Electronic Equipment Regulations 2012) China RoHS (MIIT Order No. 32)	
	Applicable standards	EN/IEC 61326-1	
Material	Case: ABS		
Weight	Approx. 80 g		

\*1: Includes alarm output load current and analog output current.

\*2: The response time is the time it takes for the output change to reach 90%.

\*3: To convert temperature values such as measurement temperature range and accuracy to Fahrenheit temperature, use (Fahrenheit temperature = Celsius temperature x 1.8 + 32).

\*4: To convert relative values such as repeatability and temperature drift to Fahrenheit temperatures, use 1°C = 1.8°F.

● Specifications are subject to change without prior notice.

**OPTEX**  
**FA** OPTEX FA CO., LTD.

91 Chudoji-Awata-cho, Shimogyo-ku, Kyoto 600-8815 JAPAN  
TEL. +81-75-325-1314 FAX. +81-75-325-2936  
https://www.optex-fa.com

